

ENERGY SAVING

AIR HANDLING UNITS



 **VENTS**

2010

*Fresh air in
your house!*



CONTENTS

■ WELCOME TO THE VENTS WORLD!	page 2
■ VENTILATION IN OUR LIFE	page 4
■ MOTOR DESCRIPTION AND OPERATING PRINCIPLE	page 6
■ EC motors advantages	page 7
■ Ventilation with heat recovery	page 8
■ Air handling units design	page 10
■ VENTS VPA series supply units	page 14
■ VENTS MPA...E series supply units	page 18
■ VENTS MPA...W series supply units	page 18
■ VENTS PA...E series supply units	page 28
■ VENTS PA...W series supply units	page 28
■ VENTS VA series exhaust units	page 36
■ VENTS VUT mini air handling unit with heat recovery	page 40
■ VENTS VUT mini air handling unit with EC motor and heat recovery	page 42
■ VENTS VUT H air handling unit with heat recovery	page 44
■ VENTS VUT H air handling unit with EC motor and heat recovery	page 48
■ VENTS VUT EH and VENTS VUT WH air handling units with heat recovery	page 50
■ VENTS VUT EH with EC motor and VENTS VUT WH with EC motor air handling units with heat recovery	page 56
■ VENTS VUT PE with EC motors and VENTS VUT PW with EC motors air handling units with heat recovery	page 62



■ WELCOME TO THE VENTS WORLD!

VENTS company was founded in the 90th years of the XXth century. Dynamic development of the enterprise and never ending study of consumer demand enabled rapid international leadership in the ventilation industry.

VENTS company is one of few companies to manufacture independently a wide range of products for development of ventilation systems of any complexity.

VENTS is a powerful research and development enterprise with approximately 2000 staff ensuring full production cycle from idea to end product. The production base of the company is located at more than 60 000 m² area. It includes 12 workshops equipped under the international standards and each of them may be compared to a separate plant.

Modern equipment, active implementation of advanced technologies and high level of manufacture automation are the characteristic features of VENTS company.

The company undergoes progressing development; fundamental researches and effective designs in climatic equipment industry are in the focus of the company's business strategy.

Own design department, test laboratories and production workshops enable supplying the products of high quality to market.

Special attention is paid to the manufacturing of the goods during all manufacturing stages including monitoring the technological conditions. Technical characteristics of supplied raw materials are thoroughly checked. Quality control system which meets international standard requirements ISO 9001:2000 was implemented at the enterprise.

Environmental protection is one of the basic components for the corporate development. The whole technological process at the enterprise is arranged in such a way as to exclude any negative impact for the environment. To solve the global energy saving problem we develop special climatic equipment ensuring comfort conditions for people and reducing the energy consumption significantly.



Metal workshop



Injection Molding workshop



Extrusion workshop



Domestic fan workshop



Plastic grille workshop



Commercial fan workshop



Industrial fan workshop



Air handling units workshop



Spiral wound ducts workshop



Flexible Ducts workshop

VENTS is the only exporter of ventilation equipment in Ukraine. Our goods gained consumers' acceptance in more than 80 countries of the world including the countries of Europe, America, Asia and Australia that confirms the company reliability and excellent quality of the products. Since 2008 our company is the only Ukrainian manufacturer being the member of the USA Ventilation and Conditioning Association HARDI. Worldwide recognition witnessed that VENTS is the leader of the world ventilation market.

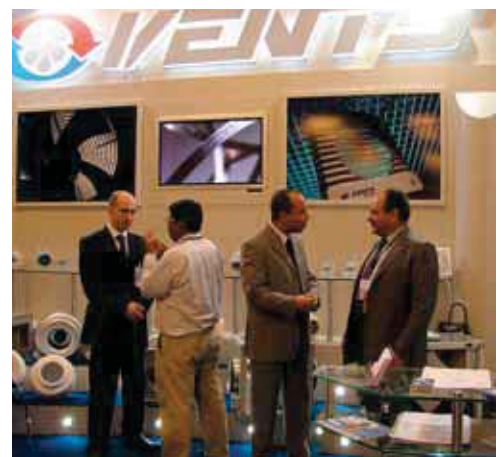

Cooperation with VENTS TM provides you with the maximum range of products of the top quality from one manufacturer.

VENTILATION IN OUR LIFE

**We are surrounded by air and breathe
in and out 20 000 litres of air every day.
How much inspired air is applicable for
the healthy life?**

▶ What Is Ventilation Required For?

There is a range of aspects to determine air quality.

- ▶ **Oxygen and Carbon Dioxide Concentration.** Oxygen decrease and carbon dioxide increase cause stuffiness in the premises.
- ▶ **Content of Harmful Substances and Dust.** High content of dust, tobacco smoke and other substances in the air badly impact human organism and can cause various lung and skin diseases.
- ▶ **Odours.** Bad smell causes discomfort or irritates nervous system.
- ▶ **Air Humidity.** Increased or decreased moisture cause discomfort and even can result in acute attacks of disease for sick people. Air humidity is important also for the atmosphere in the premises. For instance, doors, window frames, furniture may dry up of decreased humidity in winter; but they may expand in the premises with increased humidity level like swimming pools, bathrooms etc.
- ▶ **Air Temperature.** A person feels good in a premise with the temperature 21-23°C. Temperature variation causes the change of comfort feeling that influences a person's physical and mental activity.
- ▶ **Air Motion.** Increased air speed in the premises causes the feeling of draft, and decreased speed causes air blanketing. We feel the impact of any of these factors.

▶ Solution:

Any ventilation system must include simultaneous fresh air supply and extract air exhaust thus ensuring the ideal air balance in the room. In case of poor or insufficient air intake from outside the oxygen content decreases and humidity and dustiness level in the room increases. If exhaust ventilation is not provided or it is not effective, polluted air, smells, humidity and harmful substances are not removed. Furthermore, exhaust ventilation is not effective without supply ventilation and none of these systems can operate independently. It is impossible to arrange correct air exhaust from a closed vessel because removed air is not compensated. Supply ventilation in a closed vessel system is not effective either. Some objections can be raised with the example of an exhaust fan in the bathroom or in the kitchen. Once it runs, the ventilation system operates. Really. It looks like it operates. However such ventilation example shows that after extract air is removed by the fan the flat is filled with non arranged air flows from various slots in the windows, doors and other building structures. Consequently dust and odours are transported with the air flows from outside and air draught can appear. Opened windows and doors are another way for air supply. Such way of ventilation arranging is possible but it has some problems like abrupt temperature lowering of the heated premises during winter time, dust and noise from outside,

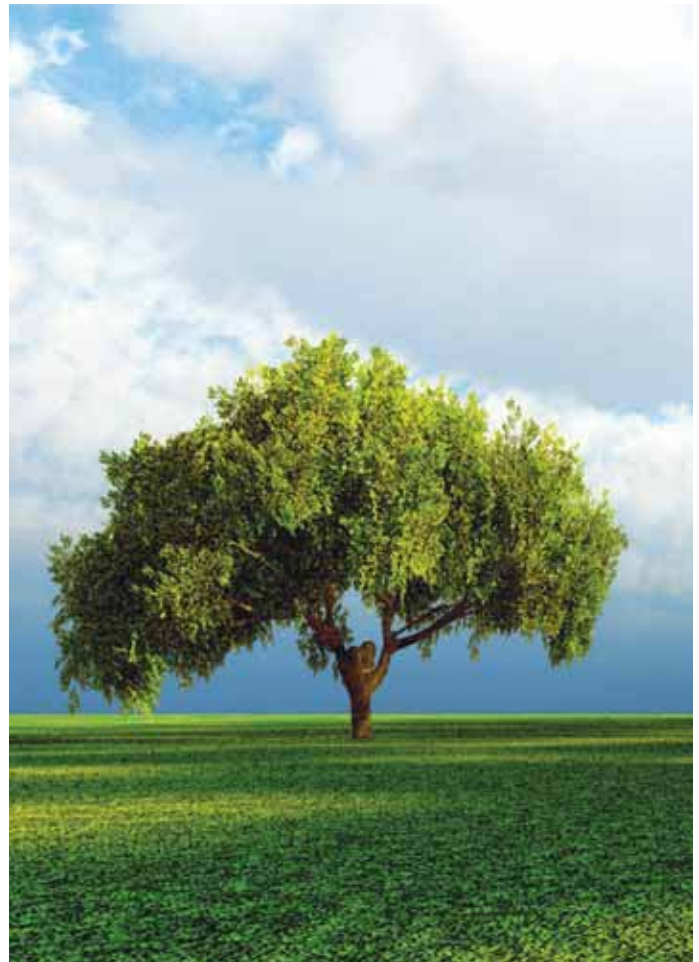

insects invasion through the opened windows, draughts and sharp temperature drop. Correct ventilation system is the only solution in this situation. Ventilation system ensures filtered air supply during summer time and filtered and heated air supply during winter time as well as removal of polluted extract air from the premises. The joint application of supply ventilation units to supply fresh air to the rooms jointly with exhaust fans provides quality ventilation in your buildings.

The issue of ventilation is the most essential subject from the point of view of thermal energy saving permanent temperature maintaining. The factors that influence the heat loss dynamics vary from wall thermal protection to heaters and heating system quality, density of wall panels joints and window joints as well as personal consumption habits.

Ventilation demands up to 45% of the total heat energy consumption in modern buildings. The reasons are as follows:

a) One half of air volume is exchanged through the open window within 30-60 min. So the heat losses grow tremendously;

b) Energy saving houses are equipped with all available facilities for sealing and thermal insulation of the buildings. Such houses are so well insulated that the heat loss share through the walls makes only 30 to 40% of the total amount.

Thus the ventilation induced heat losses remove 2/3 of the total heat.

So we come to the point of providing air exchange with minimum heat losses. From 30% to 70% of heat loss is variously estimated for the exhaust ventilation that is traditionally for residential houses. The controllable air exchange and heat recovery are the compulsory attributes in the modern house construction that are ensured by means of air handling units. The forced ventilation allows recuperating up to 90% of the exhaust air heat. Such effect is attained due to installation of the heat exchanger (recuperator). The heat exchanger allows saving heat in winter period and contributes to better operation of air conditioners jointly with ventilation in summer period. In addition the heat exchangers have heat- and sound-insulated casing that reduces the noise level produced by equipment in the room. As of today the ventilation systems based on heat exchangers are the most state of the art and progressive solution for air exchange arranging in the premises.

Due to recuperation of the unit its owner can save good money for operation costs. Use of the ventilation units with heat recovery jointly with the air conditioning systems is not only the most effective way to arrange the required microclimate in the room but to cut costs as well. In winter the heat exchanger saves heat and in summer it saves cool.

The plate heat exchanger of cross flow or counter flow type is the simplest one as it contains no movable parts and electrical connections; it separates the air streams fully; requires no additional energy consumption and maintenance.

Use of units with heat recovery in ventilation systems results in shortening of payback period and improving its ecological characteristics in view of low energy consumption, low investment for heat energy generation and its distribution, careful attitude to environment.

New series of compact air handling units with EC (electronically commutated) motors provide energy consumption reducing up to 50% as compared to traditional asynchronous motors. Operating costs will be generally reduced by 30%.

Fans with EC motors have the following advantages:

- efficient operation at any rotation speed of fan impeller (up to zero) and significant winding electrical resistance;

- low heat generation that enables reducing performance losses of refrigeration equipment and compensate for heat generation of fan motors in case of use of EC motor fans in conditioning systems;

- fan overall dimensions can be reduced in case of external rotor and EC motor design. Consequently the disadvantages related to large scale overall dimensions that are typical for fans with standard motors are minimized;

- the maximum motor speed does not depend upon frequency (operation both at 50 Hz and 60 Hz is possible);

- high efficiency at low speed;

- external rotor design makes it compact.

MOTOR DESCRIPTION AND PRINCIPLE

▶ Fan types:

Various fan types are applied in air handling units for air transportation through air ducts, direct air supply or air exhaust.

Centrifugal fans consist of two basic components – turbine and scroll casing. Impeller of centrifugal fan is a hollow cylinder with mounted blades inside, circumferentially fixed with disk plates. The hub for mounting the impeller on the shaft is located at the center of the strengthening ring.



Forward curved blades

During the impeller operation air is trapped between the blades and moves radially from the center compressed. Under centrifugal force air is transported to the scroll casing and then moved to the exhaust pipe.

Centrifugal fans incorporate forward or backward curved blades. Use of centrifugal impellers with backward curved blades allows

up to 20% energy saving. Another important privilege of backward curved blades is their high air overload capability.

Centrifugal fans with forward curved blades ensure the same air capacity and pressure characteristics as the backward curved blades do but they require smaller impeller diameter and lower speed. So they are able to attain the required result demanding less space and producing less noise.



Backward curved blades

▶ External rotor motors

External rotor motor design is similar to asynchronous motor design but the motor rotor is located outside of the stator winding and the stator with the windings is located in the motor centre. Such original modification ensures the compact size of the unit. The motor shaft rotates on the ball bearings mounted inside the stator. The impeller is fixed on the rotor casing. Such design provides air cooling of the electric motor which allows using the fans in the wide temperature range. All the motors and impellers are statically and dynamically balanced at the manufacturing facility.



▶ EC motors with external rotor

EC motor with external rotor is the innovative development of EBM PAPST company with the electronics integrated directly into the motor. The built in electronics ensures the full control over the energy consumption and speed rate and provides smooth regulation and keeping of the fan parameters. Standard fans require additional control equipment to have the similar functions. EC motors have the energy consumption by 50% less as compared to standard models. The operating costs for EC motors maintenance are also generally by 30% less. Premium efficiency of EC motors reaching up to 90% is their great advantage.

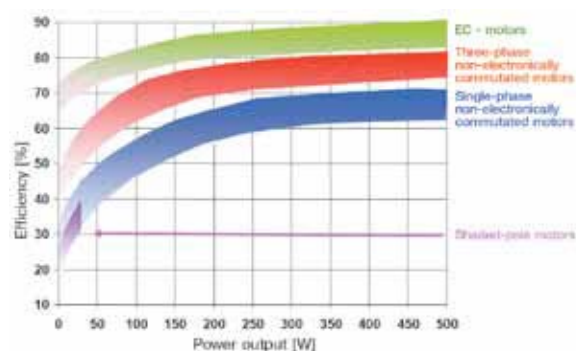

Basic principle of EC motors:

The permanent magnets integrated into the motor create magnetic field. The above phenomena disables any thermal losses in the rotor which are common with any squirrel cage motor.

change of the current direction in the stator winding is effected by means of the integrated commutating electronics based on Hall sensor (controller) which at any moment calculates and supplies to the stator the required for the continuous rotor rotation polarity. Such motor design does not need any brushes requiring regular maintenance.

EC motors are suitable for connection to direct current voltage according to the required parameters or through the switching module directly to AC supply (230, 400 V, 50/60 Hz).

High powered EC motors produce low noise level which makes their application suitable in supermarkets, hotels and other public facilities as well as in residential premises.

EC systems are featured with long service life and are designed for at least 4.5 years of continuous operation, i.e. about 40 000 operating hours. In one line with that service maintenance is minimized because of high reliability.

Due to a complex of considerable advantages the fans equipped with EC motors ensure quick pay off period for owners and investors.

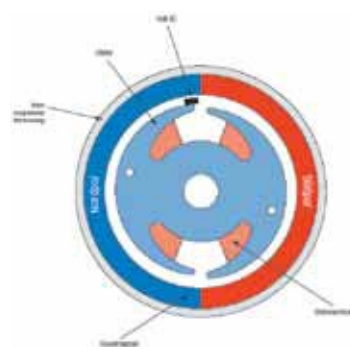

▶ EC motor advantages

COMPACT SIZE

the systems based on EC motors provide the required operating parameters by smaller fans due to their increased efficiency. Actually the fans have the minimum size.

LOW ENERGY CONSUMPTION

premium efficiency of the motor reaching up to 90% provides reducing energy consumption at least by 30% for the same operating point without speed control. In case of speed control the energy consumption is by 2-8 times less!

SMOOTH AND ACCURATE SPEED CONTROL

the fans are programmable and change the air capacity depending on any control parameter like temperature, humidity, pressure, air quality etc. Depending on a setting the EC motors change their rotation speed respectively to a control parameter change and air is supplied in the required for the system volume.

HIGH AUTOMATION DEGREE OF CONTROL PROCESS

high automation degree of control process reduces the influence of human factor.

INTEGRATED MOTOR PROTECTION

prevents rotor locking, electrical and temperature overloads that extends the equipment service life due to its resistance to change of voltage.

FULL CONTROL

fan operation can be controlled at any place of the Earth through Internet.

WIDE RANGE OF SUPPLY VOLTAGE

200-277 V of 380-480 V $\pm 15\%$.

MINIMUM CROSS SECTION OF POWER CABLE AND POWER TRANSFORMER OUTPUT

the fans have no startup currents and for that reason they consume much less energy as compared to the standard fans.

MINIMUM MAINTENANCE

long term service life (as compared to AC).

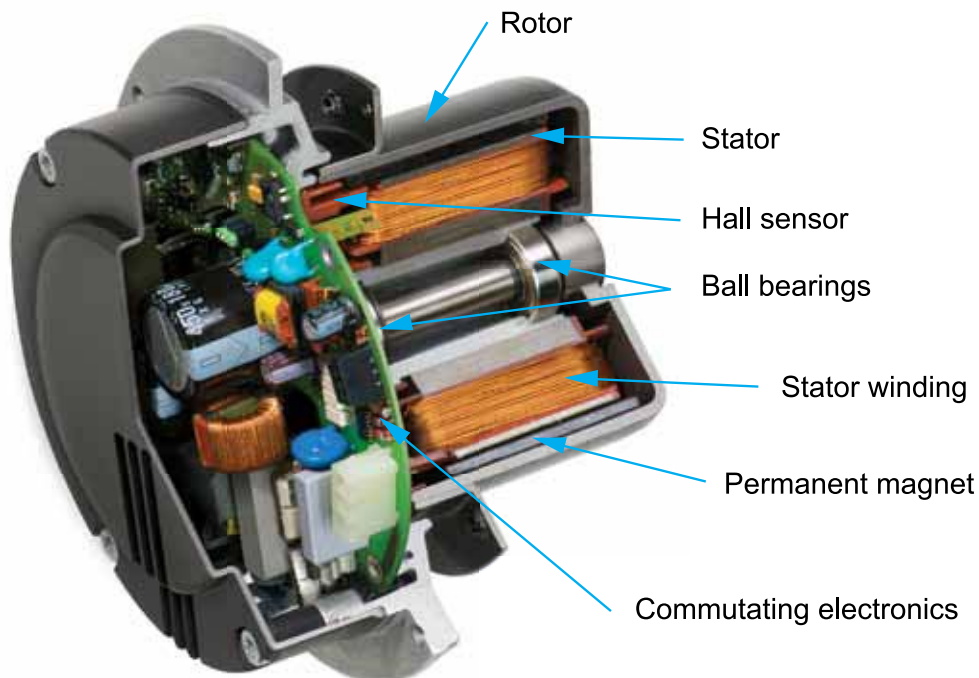

Energy saving EC motor structure

VENTILATION WITH HEAT RECOVERY

Controllable air exchange and heat recovery are the compulsory attributes in the modern construction that are ensured by means of air handling units. The forced ventilation allows recuperating up to 90% of the exhaust air heat. Such effect is attained due to installation of the heat exchanger (recuperator). The plate heat exchangers of cross flow or counter flow type are used for heat recovery in Vents VUT ventilation units. The exhaust air in the heat exchanger transfers the heat energy to the supply air.

▶ Structure and principle of operation for the plate heat exchangers

The design of the plate heat exchangers is such as to exclude transfer of contaminants, odours and microbes from exhaust air flow to supply air flow. The air flows are divided by wall elements of heat exchanger plates made of aluminium or polystyrene. Thermal energy quantity that is transferred from exhaust air to supply air depends exclusively on thermal conductivity of the applied materials and temperature difference between two flows. So warm exhaust air is warmed up and cold intake air is heated down.

Though moisture from warm air flow is not transferred to cold air flow, a part of the latent heat energy from humid exhaust air is used for heat recovery. At low outside temperatures and high exhaust air heating degree the exhaust air can be cooled to the temperature of dew point. Consequently it produces the condensed moisture and the latent vaporization heat is released. During this process the temperature difference of the air flows that cross the heat exchanger is more

than that one during no condensing and that means higher total thermal energy and consequently higher heat recovery efficiency. That is why it is so important to provide free condensate drainage from the heat exchanger.

Use of plate heat exchangers in ventilation system results in shorter payback period and better ecological characteristics ensuring the further advantages:

- low energy consumption;
- low investment for thermal energy generation and its distribution;
- no removable parts which means durability and long service life at continuous operation;
- high efficient heat recovery and little investment result in high self repayment;
- environmental protection.

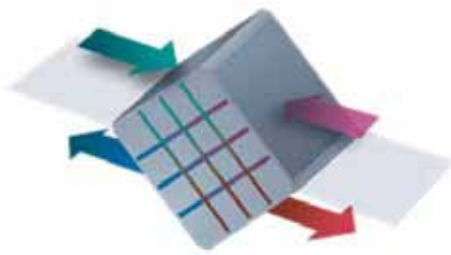

Principle of operation of plate heat recovery of cross flow type

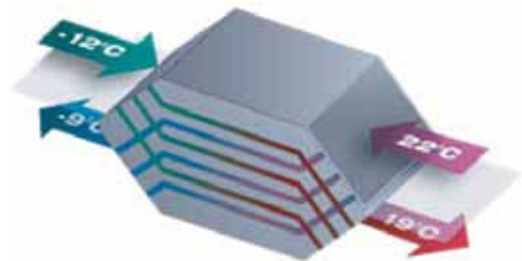

Principle of operation of plate heat recovery of counter flow type

► Design and operating principle of air handling units based on VUT 600 WH EC example.

VUT 600 WH EC unit operates as follows:

Fresh cold air from outside is supplied to VUT WH EC unit through the air ducts, gets filtered and passes further through the heat exchanger from where it is supplied to premises by means of the supply fan. Warm exhaust air from premises goes back to VUT WH EC unit through the ducts where it gets filtered, then passes again through the heat exchanger and is exhausted outside by means of the exhaust fan. The exchange of heat energy of the warm contaminated air from the premises with the fresh cold air from outside takes place in the heat exchanger. That reduces heat losses and consequently cuts the heating costs in winter time.

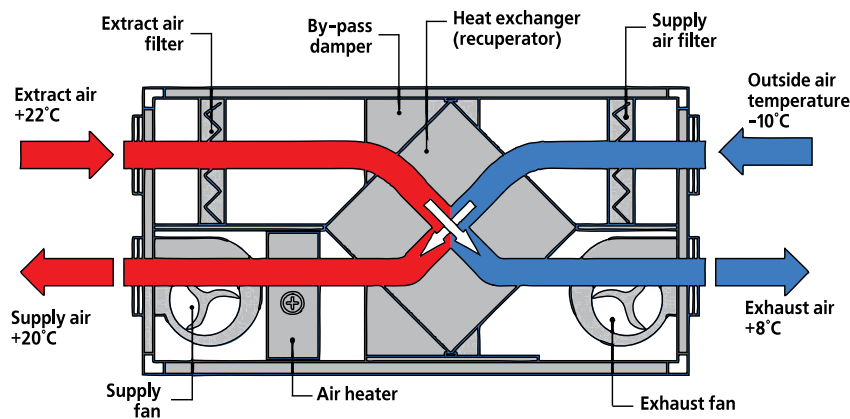

► Recuperation economic analysis:

Air capacity: 500 m³/h

t₁ – intake temperature;

t₂ – outside temperature (10 °C);

t₃ – internal temperature (+22 °C).

Recuperation efficiency is calculated as follows: K_{ef} = 60%

Air temperature after heat exchanger:

$$t_1 = t_2 + C_{ef} (t_3 - t_2) = (10) + 0,60 (22 - 10) = 9,2 \text{ °C}$$

To heat the air temperature up to the temperature 19,2 °C (10 up to 9,2 °C)

the required energy consumption is:

$$P(Wt) = L(m^3/h) \times 0,34 \times t(°C) = 500 \text{ m}^3/h \times 0,34 \times 19,2 = \mathbf{3264 \text{ W}}$$

Automation and control:

▶ VENTS air handling units supplied with incorporated automation system with control board.

Interface control board has multifunctional buttons, failure and emergency indicator. The standard set includes multifunctional control panel with graphic LCD indicator.

Functions:

- ▶ Maintaining supply air temperature
- ▶ Maintaining air temperature in the premises
- ▶ Ventilation rate control
- ▶ Heat recovery by means of the plate heat exchanger
- ▶ Plate heat exchanger icing protection
- ▶ Electric heater overheating protection
- ▶ Program of correct emergency shutdown of the air heaters
- ▶ Supply air filter clogging indication
- ▶ Setting unit operation mode
- ▶ Setting week operation program with ventilation rate control
- ▶ Daily timer
- ▶ Seasonal operation mode setting
- ▶ Filter replacement timer
- ▶ Automatic detection of connected devices
- ▶ Failure indication by means of text and light alarm messages
- ▶ Failure light alarm indication
- ▶ Interface language option

Filter

▶ High degree of air purification is achieved due to G4 F7 incorporated panel type filters on metal frames. Filter size match the European Norms and Standards. Filter clogging control by means of build in automation system as well as filter easy removal and cleaning ensure their quality and durability.

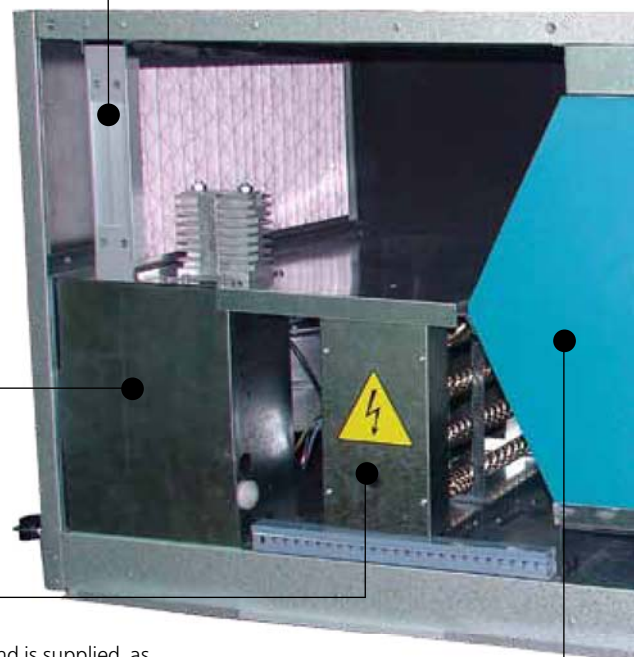

Heater:

- ▶ Electric heater is designed for air handling unit operation at low outside temperature and is supplied as a standard into delivery list.
- ▶ Electric heater is made of heat resisting stainless steel ribbed to increase the heat exchange surface area and equipped with two thermal overheating protecting thermostats.

Heat exchanger (recuperator)

▶ Plate heat exchanger with a great surface area and high efficiency made of polystyrene. The exhaust air transfers heat to the plates and the plates transfer heat to supply air flow. The heat exchange efficiency is up to 95% which allows reducing heating costs. The supply and exhaust air flows do not get mixed which ensures no contamination, odours, microbes transfer. By pass damper provides switching to no heat recovery mode if required.

Heat recovery



Control system



Effective insulation



**Photo:
VUT 600 EH EC**

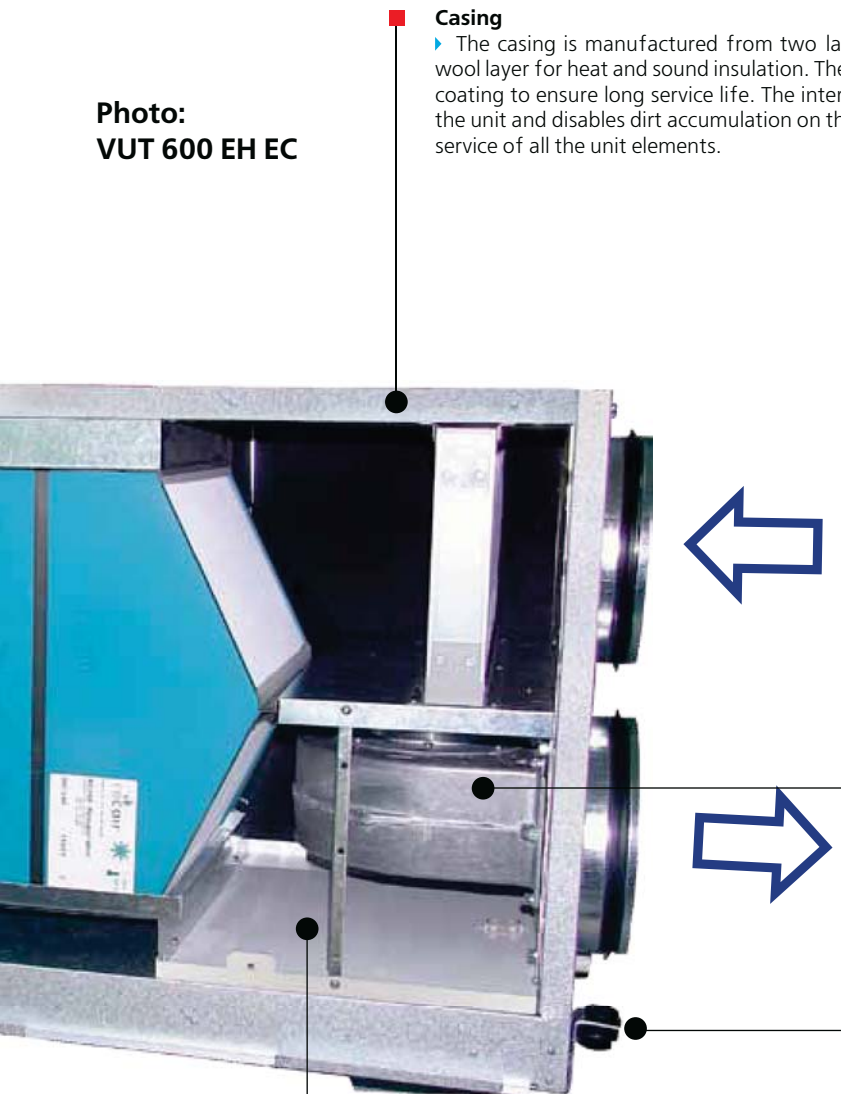

Casing

▶ The casing is manufactured from two layers aluminum zinc compound internally filled with the mineral wool layer for heat and sound insulation. The internal sheet is made of aluminum zinc steel plates with varnish coating to ensure long service life. The internal galvanized steel plate provides the surface hygienic purity of the unit and disables dirt accumulation on the panel. The side panels can be easily removed for inspection and service of all the unit elements.

Fan with EC motor:



▶ Air supply and exhaust is effected by means of two centrifugal single inlet EC fans equipped with backward curved blades.
 ▶ EC motor is a synchronous brushless electronically commutated motor. EC motors have energy consumption by up to 50% less as compared to standard motors of the same capacity. The operating costs for their maintenance are by 30% less.
 ▶ Such fan design ensures minimum noise level combined with high capacity.

Anti vibration rubber mount:

▶ Mounting the unit onto the rubber anti vibration mounts makes its operation totally quiet and vibration free and disables vibration transfer to buildings.

Drain pan:

▶ The unit is equipped with the drain pan of painted steel for condensate collection. Draining pipes for condensate drainage on the bottom are connected to the draining system.

Easy mounting



Energy saving EC motors

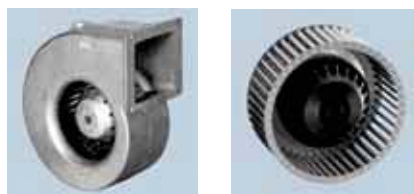

Easy maintenance



SUPPLY UNITS

EXHAUST UNITS

▶ VENTS VPA Series



▶ Sound and heat insulated fan units with the air capacity up to 1520 m³/h are designed to provide fresh filtered air to premises. For operation of the units during low outside temperatures electrical heating coils are installed. Compatible with Ø 100, 125, 150, 200, 250, 315 mm round air ducts.

▶ VENTS MPA...E Series



▶ Sound and heat insulated fan units with the air capacity up to 3500 m³/h are designed to provide fresh filtered air to premises. For operation of the units during low outside temperatures the electrical heating coils are installed. Compatible with 400x200, 500x250, 500x300, 600x300, 600x350 mm rectangular air ducts.

▶ VENTS MPA...W Series



▶ Sound and heat insulated fan units with the air capacity up to 6500 m³/h are designed to provide fresh filtered air to premises. For operation of the units during low outside temperatures water heating coils are installed. Compatible with 400x200, 500x250, 500x300, 600x300, 600x350 and 800x500 mm rectangular air ducts.

▶ VENTS VUT PA... E Series



▶ Compact suspended sound insulated fan units with the air capacity up to 3350 m³/h are designed to provide fresh filtered air to premises. For operation of the units during low outside temperatures electrical heating coils are installed. Compatible with 400x200, 500x300, 600x350 mm rectangular air ducts.

▶ VENTS PA...W Series



▶ Compact suspended sound insulated fan units with the air capacity up to 4100 m³/h are designed to provide fresh filtered air to premises. For operation of the units during low outside temperatures water heating coils are installed. Compatible with 400x200, 500x300, 600x350, 700x400 mm rectangular air ducts.

▶ VENTS VA Series



▶ Compact suspended sound insulated fan units with the air capacity up to 4450 m³/h are designed to provide exhaust air removal from premises. Compatible with 400x200, 500x300, 600x350, 600x350, 700x400 mm rectangular air ducts.



VENTS VPA series supply units

Air capacity up to 1520 m³/h

page
14



VENTS MPA...E series supply units

Air capacity up to 3500 m³/h

page
18



VENTS MPA...W series supply units

Air capacity up to 6500 m³/h

page
18



VENTS PA...E series supply units

Air capacity up to 3350 m³/h

page
28



VENTS PA...W series supply units of

Air capacity up to 4100 m³/h

page
28



VENTS VA series exhaust units

Air capacity up to 4450 m³/h

page
36

Series
VENTS VPA



LCD control panel

Supply units with the air capacity up to **1520 m³/h** in the compact sound and heat insulated casing with electric heating battery.

■ **Description**

The fan unit provides filtration, heating and supply of fresh air to premises with the air capacity from 200 up to 1500 m³/h. All the models are compatible with 100, 125, 150, 200, 250, 315 mm round air ducts.

■ **Casing**

The casing is made of aluzink with internal heat and sound insulating 25 mm layer of mineral wool.

■ **Filter**

G4 filter ensures high degree of supply air purification.

■ **Heater**

Electric heating battery is designed for supply air heating during winter and off season time.

■ **Fan**

Centrifugal fan with backward curved blades and built in thermal overheating protection with automatic restart. High powered motor modification (VPA 1) is available for some standard sizes. The fan motor and impeller are dynamically balanced in two planes. The motor ball bearings are maintenance free and are designed for at least 40 000 hours service life.

■ **Control and automation**

The supply unit is available in two modifications:

1. No control. Customer defined and customer selected automation system.
2. Integrated control and automation system to ensure control of air capacity, setting temperature of supply air, filter clogging degree etc. In addition the automation system provides protection against overheating of heating elements. The remote unit control is effected by means of the external control unit with 10 m wire supplied as a standard.

■ **Control and protection functions**

- ▶ remote switching the unit on and off
- ▶ setting of required temperature of intake air and maintaining selected temperature mode by means of the control panel (electric air heater control by means of the optosymistor)
- ▶ fan speed control by means of the control panel (3 speed modes)
- ▶ working out of the required patterns during the unit switching on and off
- ▶ the unit daily or week timer operation
- ▶ active protection against overheating of heating elements
- ▶ disabling electric air heating battery operation when the motor is not running
- ▶ electric heater overheating protection by means of two thermostats
- ▶ filter clogging control though the differential pressure sensor

■ **Mounting**

Air supply unit can be mounted on the floor, attached to a ceiling with a seat angle with anti vibration mounts or attached to a wall by means of the brackets. The unit can be mounted either in service spaces (balcony, storage room, underground floor, roof space etc.) or in the main space by placing the unit above the suspended ceiling or in the pocket. The unit can be mounted in any position except for the vertical one with vertical air downstream because tubular heating elements are not allowed under the fan. Free access to the unit shall be provided for maintenance and filter cleaning.

Designation key: _____

Series		Flange diameter, mm	Electric heater power [kW]	Phase
VENTS VPA	1 – high powered motor	100; 125; 150; 200; 250; 315	1,8; 2,4; 3,4; 3,6; 5,1; 6; 9	1 – single phase; 3 – three phases

Offered options to the units



Technical data:

	VPA 100 1,8 1	VPA 125 2,4 1	VPA 150 2,4 1	VPA 150 3,4 1	VPA 150 5,1 3	VPA 150 6,0 3	VPA 200 3,4 1	VPA 200 5,1 3	VPA 200 6,0 3
Unit supply voltage [V / 50 Hz]	1~ 230		1~ 230		3~ 400		1~ 230		3~ 400
Maximum fan power [W]	73		75		98		193		
Fan current [A]	0,32		0,33		0,43		0,84		
Electric heater capacity [kW]	1,8	2,4	2,4	3,4	5,1	6,0	3,4	5,1	6,0
Electric heater current [A]	7,8	10,4	10,4	14,8	7,4	8,7	14,8	7,4	8,7
Number of electrical heating elements	3	3	2	2	3	3	2	3	3
Total power of the unit [kW]	1,873	2,475	2,498	3,498	5,198	6,098	3,593	5,293	6,193
Total current of the unit [A]	8,12	10,73	10,83	15,23	7,83	9,13	15,64	8,24	9,54
Air capacity [m ³ /h]	190		285		425		810		
RPM	2830		2800		2705		2780		
Noise level at 3m [dB[A]]	27		28		29		30		
Operating temperature [°C]	25 up to +55		25 up to +55		25 up to +55		25 up to +45		
Casing material	aluzink		aluzink		aluzink		aluzink		
Insulation	25 mm mineral wool		25 mm mineral wool		25 mm mineral wool		25 mm mineral wool		
Filter	G4		G4		G4		G4		
Connected air duct size [mm]	100		125		150		200		
Weight, [kg]	50		50		50		52		

Technical data:

	VPA 250 3,6 3	VPA 250 6,0 3	VPA 250 9,0 3	VPA 315 6,0 3	VPA 315 9,0 3	VPA 1 315 6,0 3	VPA 1 315 9,0 3
Unit supply voltage [V / 50 Hz]	3~ 400			3~ 400			
Maximum fan power [W]	194			171		296	
Fan current [A]	0,85			0,77		1,34	
Electric heater capacity [kW]	3,6	6,0	9,0	6,0	9,0	6,0	9,0
Electric heater current [A]	5,3	8,7	13,0	8,7	13,0	8,7	13,0
Number of electrical heating elements	3	3	3	3	3	3	3
Total power of the unit [kW]	3,794	6,194	9,194	6,171	9,171	6,296	9,296
Total current of the unit [A]	6,15	9,55	13,85	9,47	13,77	10,04	14,34
Air capacity [m ³ /h]	990			1190		1520	
RPM	2790			2600		2720	
Noise level at 3m [dB[A]]	30			30		30	
Operating temperature [°C]	25 up to +50			25 up to +50		25 up to +45	
Casing material	aluzink			aluzink			
Insulation	25 mm mineral wool			25 mm mineral wool			
Filter	G4			G4			
Connected air duct size [mm]	250			315			
Weight, [kg]	52			62			

Unit overall dimensions:

Type	Dimensions, [mm]					
	∅D	B	B1	H	L	L1
VPA 100	99	382	421,5	408	800	647
VPA 125	124	382	421,5	408	800	647
VPA 150	149	455	496,5	438	800	647
VPA 200	199	487	526,5	513	835	684
VPA 250	249	487	526,5	513	835	684
VPA 315	314	527	566,5	548	900	750

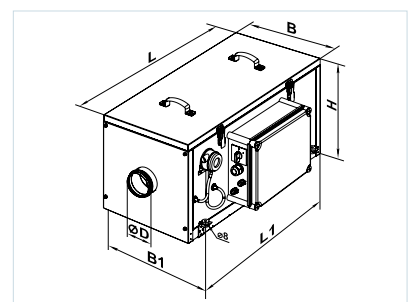

SUPPLY UNITS

VENTS VPA

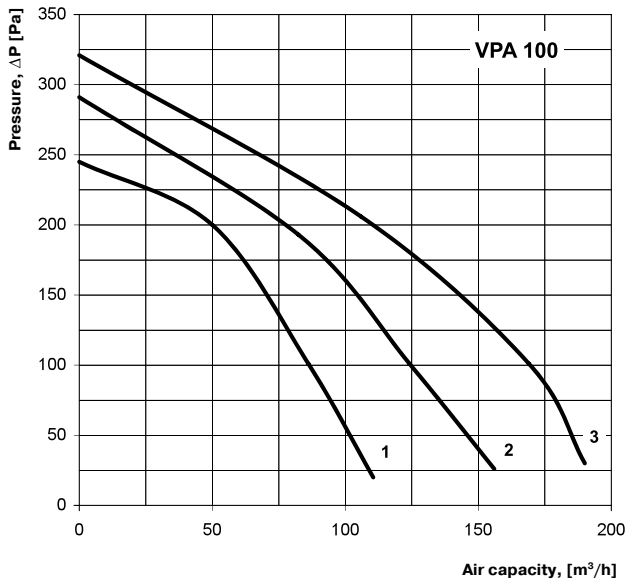

Sound power level	Hz	Octave frequency band [Hz]								
		Tot.	63	125	250	500	1000	2000	4000	8000
L_{WA} to inlet	dB(A)	50	30	47	47	35	40	37	28	16
L_{WA} to outlet	dB(A)	58	39	50	56	49	45	42	33	23
L_{WA} to environment	dB(A)	31	5	21	28	24	19	13	4	0

VENTS VPA

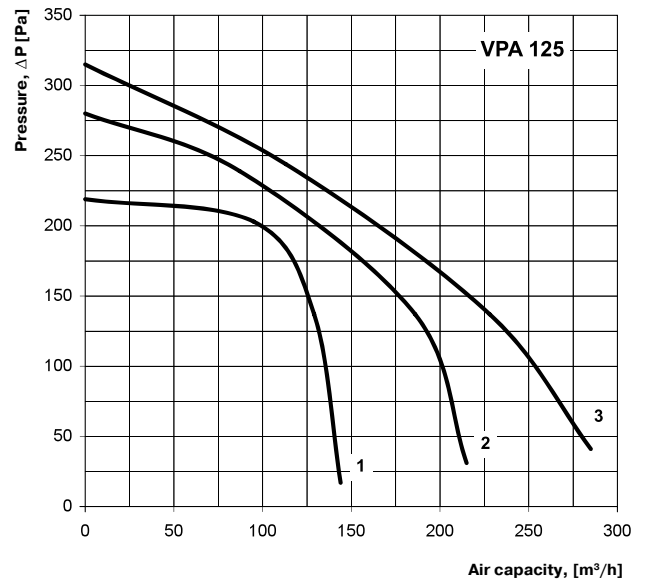

Sound power level	Hz	Octave frequency band [Hz]								
		Tot.	63	125	250	500	1000	2000	4000	8000
L_{WA} to inlet	dB(A)	52	31	48	48	36	41	40	32	18
L_{WA} to outlet	dB(A)	62	40	53	56	52	47	47	37	23
L_{WA} to environment	dB(A)	33	9	24	33	26	17	16	3	4

VENTS VPA

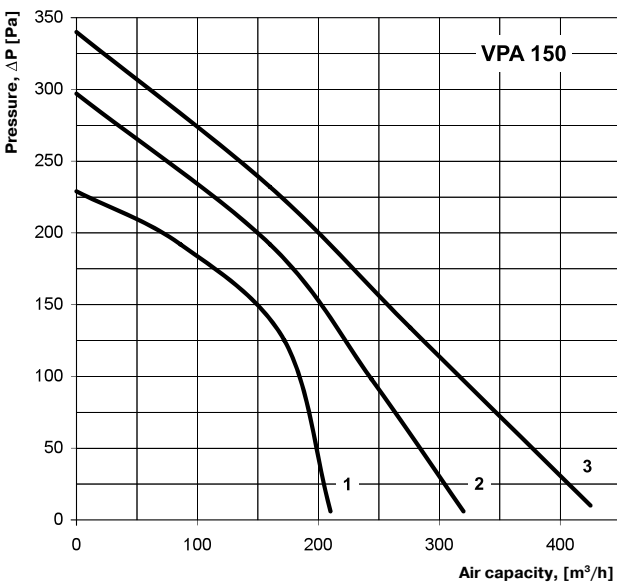

Sound power level	Hz	Octave frequency band [Hz]								
		Tot.	63	125	250	500	1000	2000	4000	8000
L_{WA} to inlet	dB(A)	65	37	53	63	50	53	53	45	30
L_{WA} to outlet	dB(A)	63	22	43	53	52	57	57	46	36
L_{WA} to environment	dB(A)	41	14	34	39	19	27	19	7	0

VENTS VPA

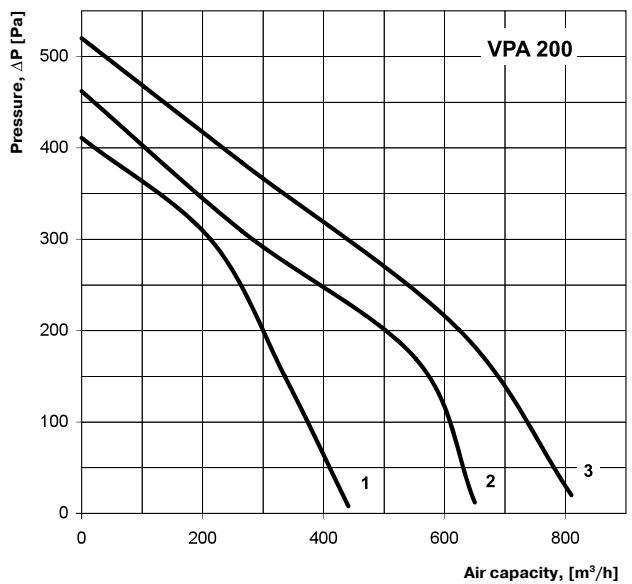

Sound power level	Hz	Octave frequency band [Hz]								
		Tot.	63	125	250	500	1000	2000	4000	8000
L_{WA} to inlet	dB(A)	65	41	58	59	56	60	62	56	41
L_{WA} to outlet	dB(A)	71	46	57	63	64	66	66	58	45
L_{WA} to environment	dB(A)	46	15	31	43	40	34	30	22	8

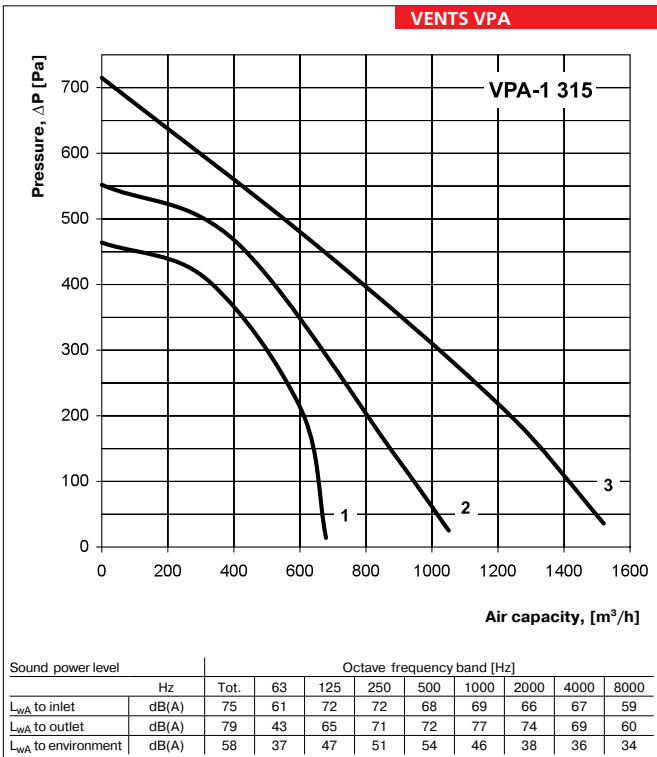
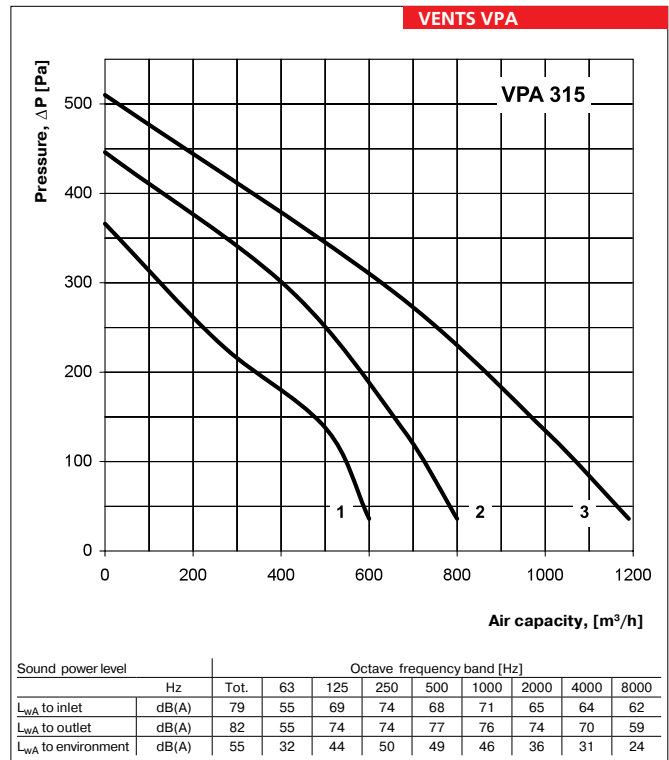
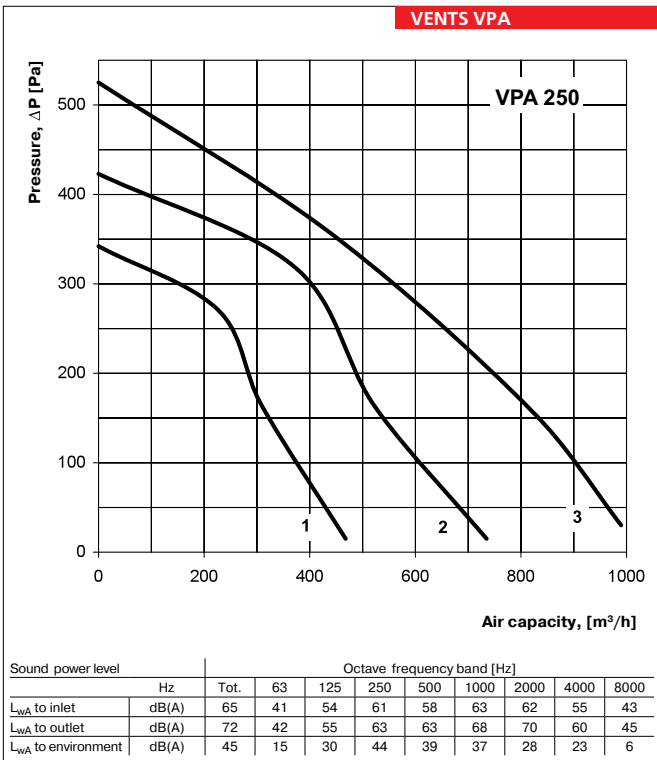

Accessories to supply units:

Type	Replaceable filter	Filter type
VPA 100 1,8 1	SF VPA 100/125 G4	panel filter
VPA 125 2,4 1		
VPA 150 2,4 1	SF VPA 150 G4	panel filter
VPA 150 3,4 1		
VPA 150 5,1 3		
VPA 150 6,0 3		
VPA 200 3,4 1	SF VPA 200/250 G4	panel filter
VPA 200 5,1 3		
VPA 200 6,0 3		
VPA 250 3,6 3		
VPA 250 6,0 3	SF VPA 315 G4	panel filter
VPA 250 9,0 3		
VPA 315 6,0 3		
VPA 315 9,0 3	SF VPA 315 G4	panel filter
VPA 1 315 6,0 3		
VPA 1 315 9,0 3		

Series
VENTS MPA E



LCD control panel

Supply units with the air capacity up to **3500 m³/h** in the compact sound and heat insulated casing with electric heater

Series
VENTS MPA W



SAS908 control panel

Supply units with the air capacity up to **6500 m³/h** in the compact sound and heat insulated casing with water heater

■ **Description**

Air supply MPA unit is a complete ventilation unit for air filtration, air heating and supply to premises. Compatible with 400x200, 500x250, 500x300, 600x300, 600x350 и 800x500 mm rectangular air ducts.

■ **Casing**

The casing is made of aluzink with internal 25 mm heat and sound insulating layer made of mineral wool.

■ **Filter**

G4 incorporated filter ensures high degree of supply air purification.

■ **Heater**

Both electric heater (MPA E models) and water/glycol heating coils (MPA W models) are used for heating of supply air during winter and off season period.

Tubular heating elements of the electric fan heater are ribbed to increase the heat exchange surface area and heat transfer to supply air.

■ **Fan**

Centrifugal double inlet fan with forward curved blades and in build thermostatic protection with automatic restart. The fan motor and impeller are dynamically balanced in two planes. The ball bearings in the electric motor are maintenance free and designed for at least 40000 hours operation.

■ **Control and automation**

Two options for supply unit modifications are possible:

1. No control. Customer defined and customer selected automation system.
2. Built in control and automation system provides

the fan air capacity control (3 speeds), intake air temperature setting, filter clogging degree control.

Additionally the automation system provides thermal overheating protection for the tubular heating elements. The remote control of the unit is effected by means of external control unit with 10 meters wire supplied as a standard.

Supply units MPA 3200 W, MPA 3500 W, MPA 5000 W have no control panel.

■ **MPA E control and protection functions**

- ▶ remote switching the unit on and off;
- ▶ setting and maintaining the desired temperature of the supply air with the control panel;
- ▶ motor speed controlling and regulating the unit air capacity accordingly by means of the control panel;
- ▶ working out of the required patterns during the unit switching on and off;

Designation key: _____

Series
VENTS MPA

Rated air flow, m ³ /h
800, 1200, 1800, 2500, 3200, 3500, 5000

Heater type	Phase
E electrical heating elements;	1 – single phase;
W water coils;	3 – three phase

———— **Offered options to the units** ————



page 24

page 24

- ▶ unit timer dependent operation;
- ▶ active electric heating elements overheating protection;
- ▶ disabling electric air heater operation when the motor is not running;
- ▶ two electric heater over heating thermostats;
- ▶ filter clogging control through the differential pressure sensor.

■ MPA W control and protection functions

- ▶ switching the unit on and off;
- ▶ switching to one of three available motor speed;
- ▶ keeping the set temperature of supply air by means of controlling the three way valve actuator that regulates the heat medium supply to the heater;
- ▶ water (glycol) heating coils freezing protection as the leaving air temperature and leaving heat medium temperature sensors require;

- ▶ controlling the of external circulation pump operation installed on the heat medium entering into the water (glycol) coils;
- ▶ controlling the condensing unit of the air cooler with respect to the indoor temperature in case of additional air cooler in the duct;
- ▶ controlling supply fan operation;
- ▶ air filter clogging control;
- ▶ controlling the external air damper actuator;
- ▶ system shutdown as the fire alarm requires.

Due to the mixing unit the control panel can keep the set indoor temperature by means of regulating the heat medium flow through the water (glycol) coils. The use of the mixing unit with the pump provides the referred above regulation with the pressure difference of the heat medium in the main and return line above 40 kPa. The mixing unit with the pump serves for freezing protection of the heat

exchanger and its operation algorithm provides some time span for the users to take required measures in case of emergency.

■ Mounting

The supply unit can be mounted on the floor, suspended to the ceiling by means of a seat angle with a flexible connector or fixed to the wall using brackets. The unit can be installed either in such service spaces as balcony, storeroom, basement, roof space or in main premises above the suspended ceiling, in the pocket or placed directly in the room. The unit can be mounted in any position but the vertical one with air downstream because the heating elements are not allowed under the fan. Access for the unit maintenance and filter cleaning shall be provided.

Unit overall dimensions:

Type	Dimensions, [mm]									
	B	B1	B2	B3	H	H1	H2	L	L1	L2
MPA 800 E1	400	420	549	500	200	220	352	650	530	
MPA 1200 E3	400	420	549	500	200	220	352	650	530	
MPA 1800 E3	500	520	649	600	250	270	480	800	680	
MPA 2500 E3	500	520	649	600	300	320	480	800	680	
MPA 3200 E3	600	620	759	710	300	320	530	1000	880	440
MPA 3500 E3	600	620	759	710	350	370	530	1000	880	440

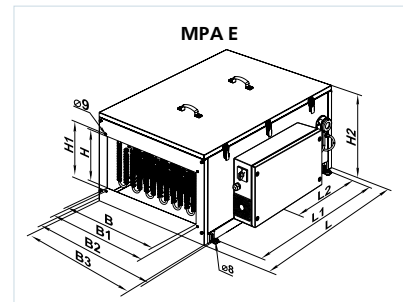

Unit overall dimensions:

Type	Dimensions, [mm]									
	B	B1	B2	B3	H	H1	H2	L	L1	L2
MPA 800 W	400	420	549	500	200	220	352	650	530	
MPA 1200 W	400	420	549	500	200	220	352	650	530	
MPA 1800 W	500	520	649	600	250	270	480	800	680	
MPA 2500 W	500	520	649	600	300	320	480	800	680	
MPA 3200 W	600	620	759	710	300	320	530	1000	880	440
MPA 3500 W	600	620	759	710	350	370	530	1000	880	440
MPA 5000 W	800	820	971	925	500	520	670	1299	720	360

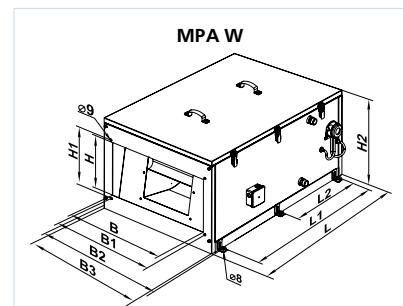

SUPPLY UNITS

Technical data:

	MPA 800 E1	MPA 800 W	MPA 1200 E3	MPA 1200 W
Unit supply voltage [V / 50 Hz]	1~ 230		3~ 400	1~ 230
Maximum fan power [W]	245		410	
Fan current [A]	1,08		1,8	
Electric heater capacity [kW]	3,3		9,9	
Electric heater current [A]	14,3		24,8	
Number of water (glycol) coil rows		4		4
Total power of the unit [kW]	3,55	0,245	9,94	0,410
Total current of the unit [A]	15,38	1,08	26,6	1,8
Air capacity [m ³ /h]	800	750	1200	1200
RPM	1650		1850	
Noise level at 3m [dB[A]]	35		38	
Operating temperature [°C]	25 up to +45		25 up to +45	
Casing material	aluzink		aluzink	
Insulation	25 mm mineral wool		25 mm mineral wool	
Filter	G4		G4	
Connected air duct size [mm]	400x200		400x200	
Weight, [kg]	36,2	41,3	38,9	42,8

* no control box (with the control box for MPA...E +130 mm)

Technical data:

	MPA 1800 E3	MPA 1800 W	MPA 2500 E3	MPA 2500 W
Unit supply voltage [V / 50 Hz]	3~ 400	1~ 230	3~ 400	1~ 230
Maximum fan power [W]	490		650	
Fan current [A]	2,15		2,84	
Electric heater capacity [kW]	18,0		18,0	
Electric heater current [A]	45,0		45,0	
Number of water (glycol) coil rows		4		4
Total power of the unit [kW]	18,49	0,490	18,65	0,650
Total current of the unit [A]	47,15	2,15	47,84	2,84
Air capacity [m ³ /h]	2000	1870	2500	2150
RPM	1100		1000	
Noise level at 3m [dB[A]]	40		45	
Operating temperature [°C]	25 up to +45		25 up to +45	
Casing material	aluzink		aluzink	
Insulation	25 mm mineral wool		25 mm mineral wool	
Filter	G4		G4	
Connected air duct size [mm]	500x250		500x300	
Weight, [kg]	61,5	62,5	62	63

* no control box (with the control box for MPA...E +130 mm)

Technical data:

	MPA 3200 E3	MPA 3200 W	MPA 3500 E3	MPA 3500 W	MPA 5000 W
Unit supply voltage [V / 50 Hz]	3~ 400Y		3~ 400Y		3~ 400
Maximum fan power [W]	1270		1270		1800
Fan current [A]	2,3		2,3		4,5
Electric heater capacity [kW]	25,2		25,2		
Electric heater current [A]	63,0		63,0		
Number of water (glycol) coil rows		4		4	4
Total power of the unit [kW]	26,47	1,270	26,47	1,270	1,80
Total current of the unit [A]	65,3	2,3	65,3	2,3	4,5
Air capacity [m³/h]	3200	3000	3500	3250	6500
RPM	1200		1200		1400
Noise level at 3m [dB(A)]	53		53		55
Operating temperature [°C]	40 up to +45		40 up to +45		25 up to +45
Casing material	aluzink		aluzink		aluzink
Insulation	25 mm mineral wool		25 mm mineral wool		
Filter	G4		G4		G4
Connected air duct size [mm]	600x300		600x350		800x500
Weight, [kg]	69,4	73,2	69,3	73,1	136

* no control box (with the control box for MPA...E +130 mm)

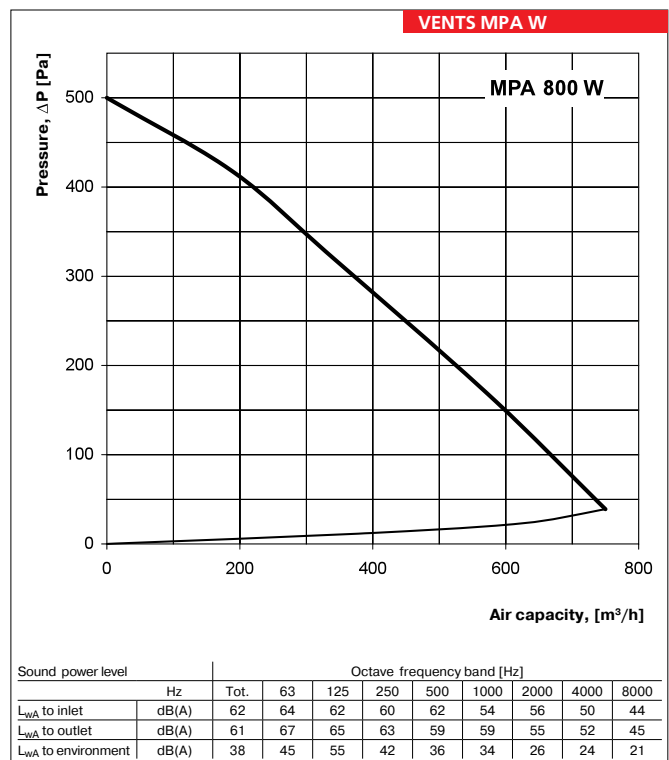
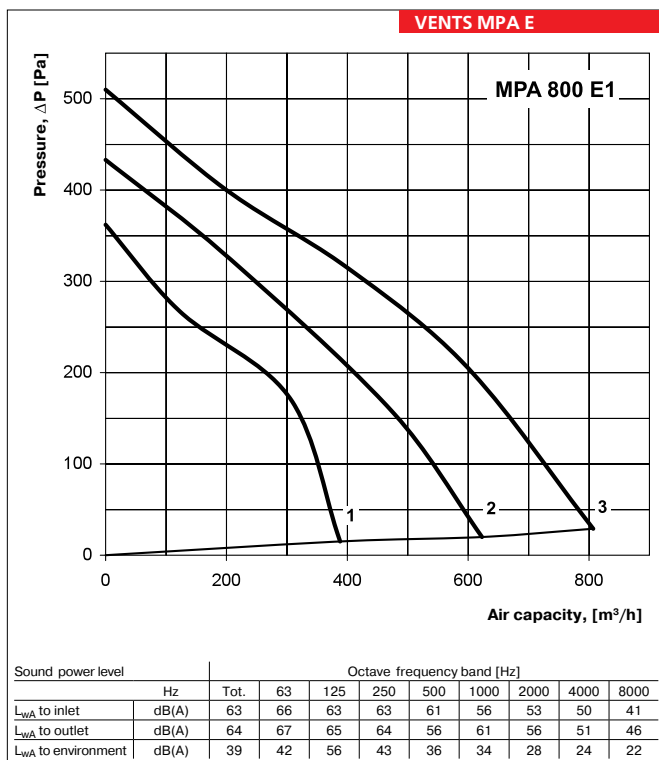

SUPPLY UNITS

VENTS MPA E

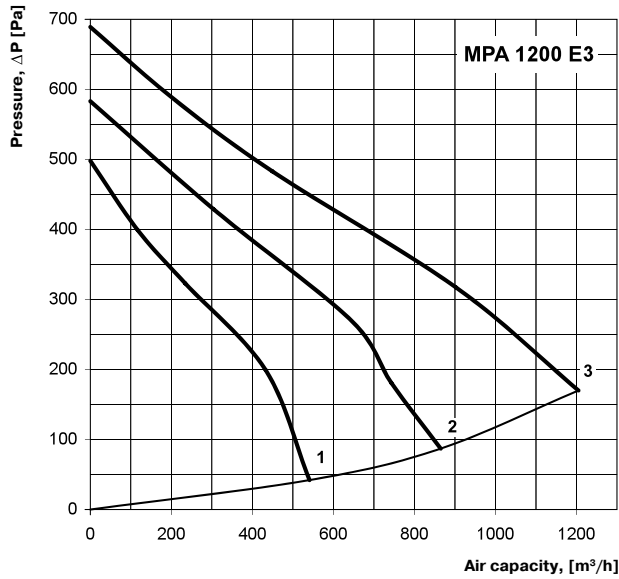

Sound power level	Hz	Octave frequency band [Hz]								
		Tot.	63	125	250	500	1000	2000	4000	8000
L_{WA} to inlet	dB(A)	67	66	66	68	66	60	63	60	55
L_{WA} to outlet	dB(A)	72	71	70	68	68	65	60	60	57
L_{WA} to environment	dB(A)	45	55	54	48	52	40	37	34	35

VENTS MPA W

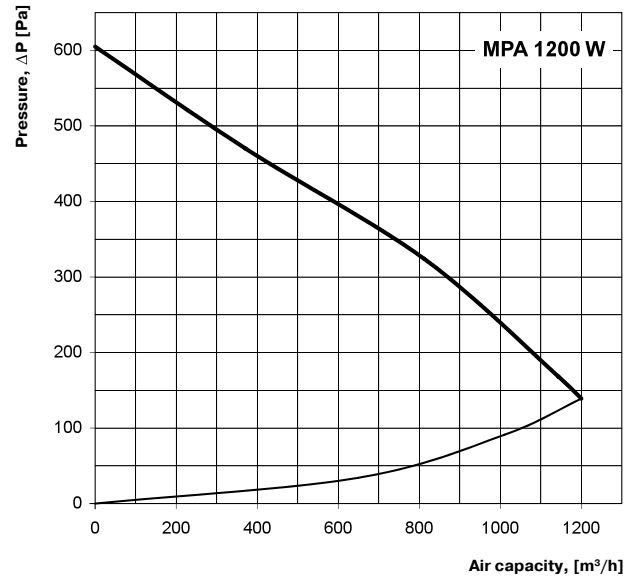

Sound power level	Hz	Octave frequency band [Hz]								
		Tot.	63	125	250	500	1000	2000	4000	8000
L_{WA} to inlet	dB(A)	71	70	68	66	68	62	61	61	56
L_{WA} to outlet	dB(A)	71	68	69	67	64	67	62	61	57
L_{WA} to environment	dB(A)	48	56	54	48	53	40	39	35	33

VENTS MPA E

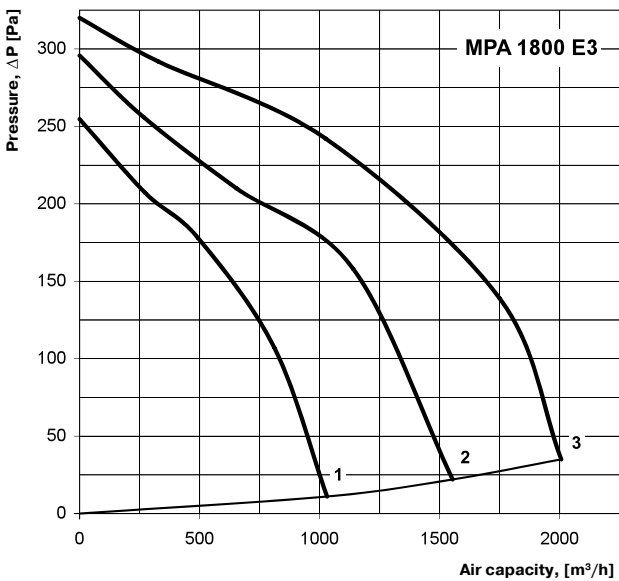

Sound power level	Hz	Octave frequency band [Hz]								
		Tot.	63	125	250	500	1000	2000	4000	8000
L_{WA} to inlet	dB(A)	74	79	76	74	67	67	64	64	54
L_{WA} to outlet	dB(A)	75	82	78	74	68	73	66	70	67
L_{WA} to environment	dB(A)	52	64	62	54	48	44	40	36	34

VENTS MPA W

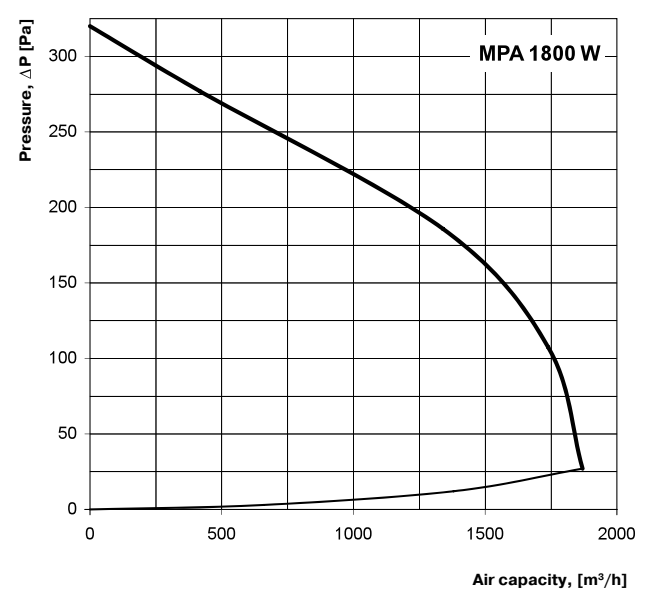

Sound power level	Hz	Octave frequency band [Hz]								
		Tot.	63	125	250	500	1000	2000	4000	8000
L_{WA} to inlet	dB(A)	73	78	77	77	67	68	62	63	57
L_{WA} to outlet	dB(A)	75	79	78	74	68	73	66	69	66
L_{WA} to environment	dB(A)	51	63	61	54	47	44	40	37	33

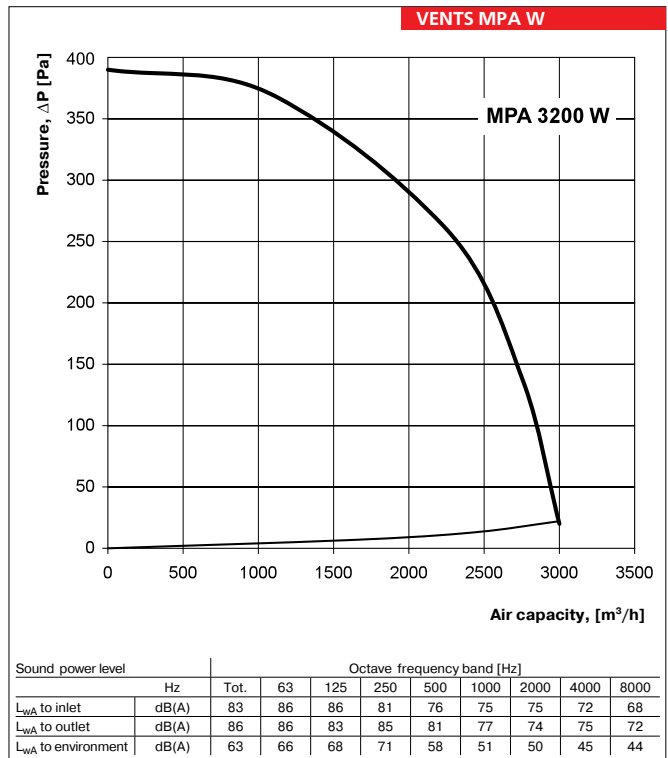
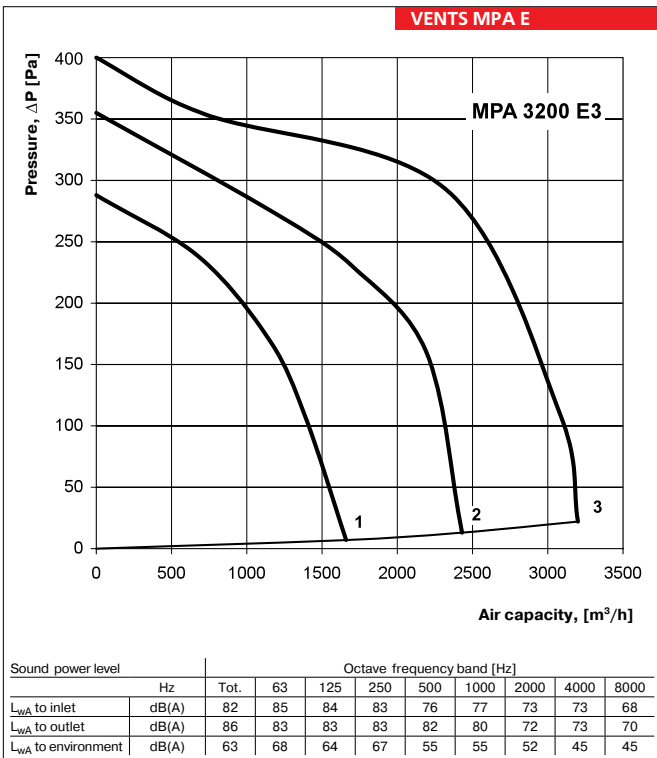
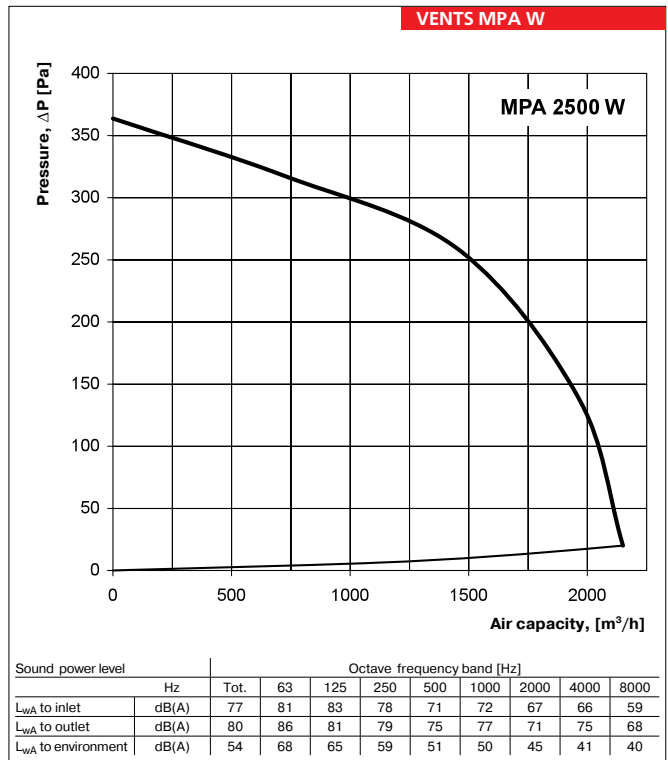
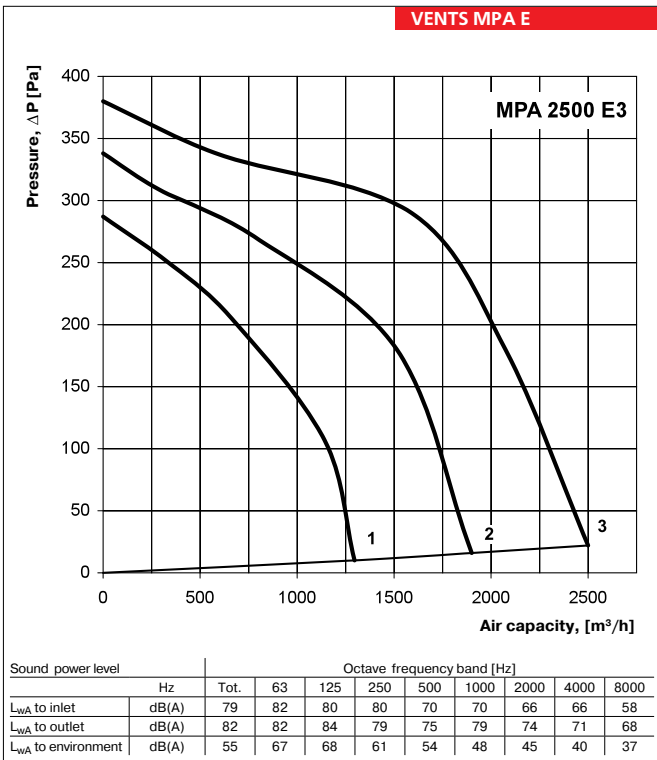

SUPPLY UNITS

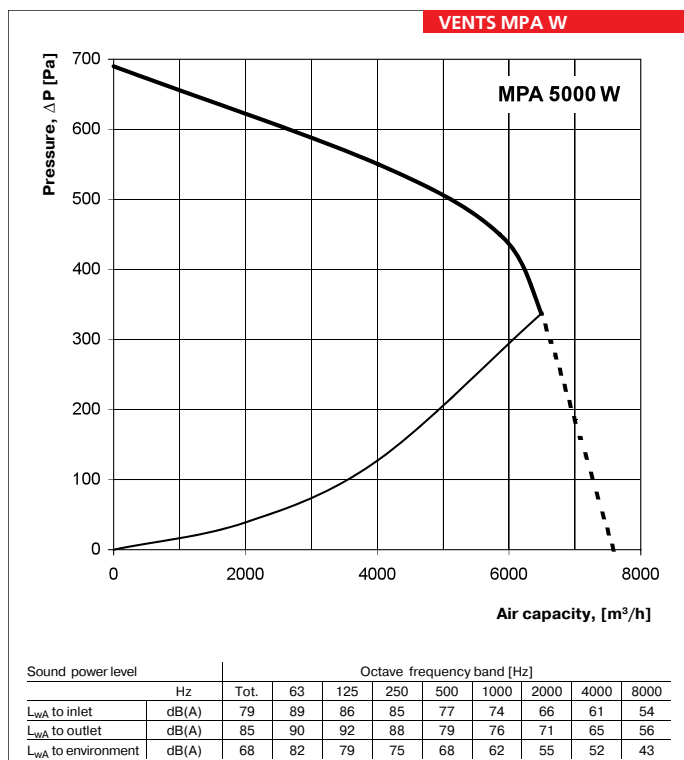
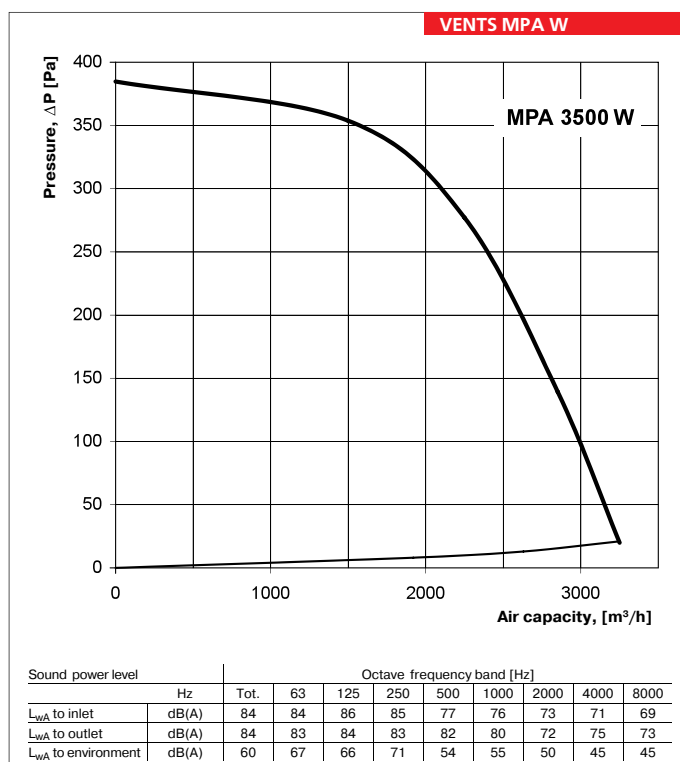
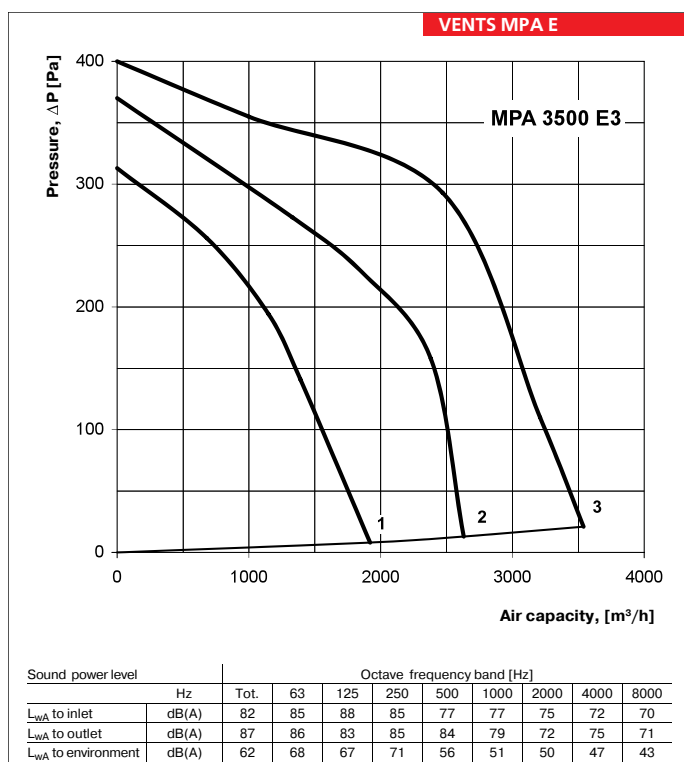

Accessories to supply units:

Type	Replaceable filter	Filter type
MPA 800 E1	SF MPA 800/1200 G4	panel filter
MPA 1200 E3		
MPA 1800 E3	SF MPA 1800/2500 G4	panel filter
MPA 2500 E3		
MPA 3200 E3	SF MPA 3200/3500 G4	panel filter
MPA 3500 E3		
MPA 800 W	SF MPA 800/1200 G4	panel filter
MPA 1200 W		
MPA 1800 W	SF MPA 1800/2500 G4	panel filter
MPA 2500 W		
MPA 3200 W	SF MPA 3200/3500 G4	panel filter
MPA 3500 W		
MPA 5000 W	SFK MPA 5000 G4	pocket filter

Office ventilation example

Air supply and exhaust ventilation in the modern office can be arranged as follows. Air handling MPA unit, exhaust fan complying with MPA unit characteristics, intake and exhaust main air ducts are mounted in the hall behind the suspended ceiling. The branchings are laid into the office premises and air distribution units. Fresh air is extracted from outside through the external

grille, filtered in the air handling unit, heated to the required temperature and supplied to the office rooms through the branch duct system. Exhaust air is extracted outside through the external grille by means of the exhaust fan. Thus the office has the permanent fresh air supply, controllable air exchange, no draughts when opened windows, no dust and no noise.



MPA unit office air exchange example.

Hot water coil parameters:

VENTS MPA W

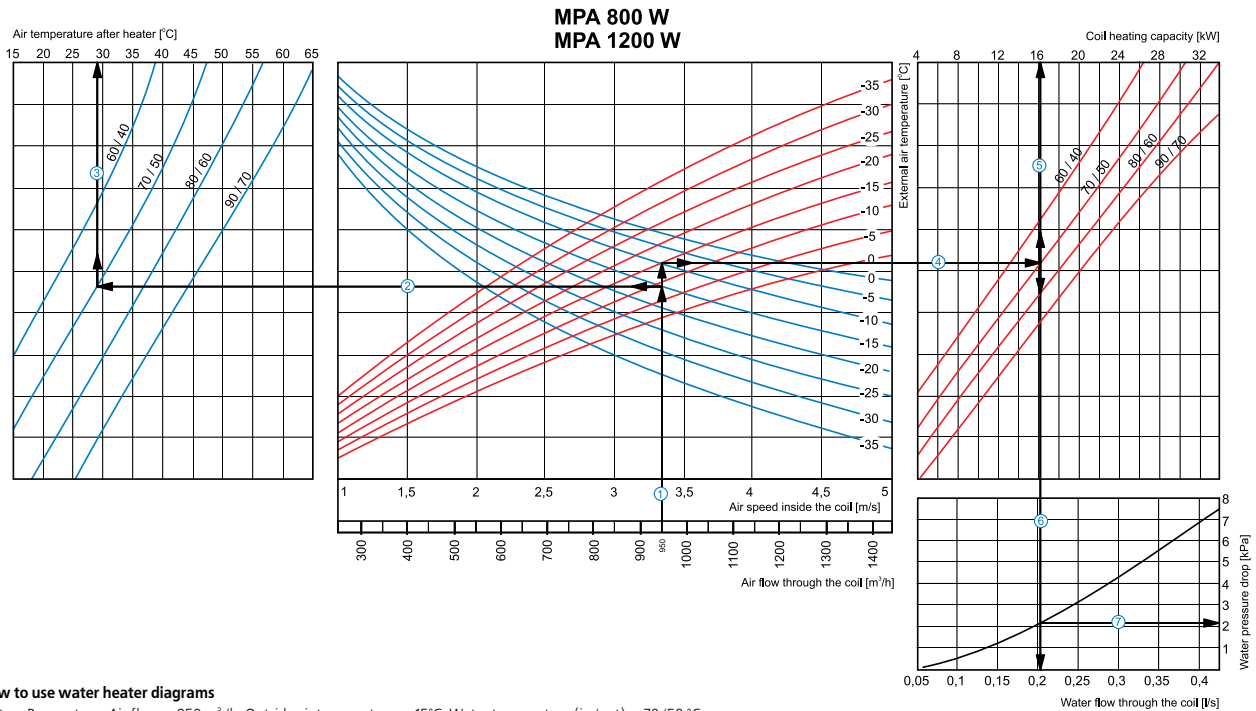

How to use water heater diagrams

System Parameters: Air flow = 950 m³/h. Outside air temperature = 15°C. Water temperature (in/out) = 70/50°C.

- Air Speed. Starting from 950 m³/h on the air flow scale draw a vertical line ① till the air speed axis which makes about 3.35 m/s.
- Supply air temperature. Prolong the line ① up to the point where it crosses the outside air temperature (blue curve), e.g. 15°C; then draw a horizontal line ② from this point to the left till crossing water in/out temperature curve (70/50°C). From this point draw a vertical line ③ to the supply air temperature axis on top of the graphic (+29°C).
- Heating coil capacity. Prolong the line ① up to the point where it crosses the outside air temperature 15°C (red curve) and draw a horizontal line ④ from this point to the right until it crosses water in/out temperature curve (70/50°C), from here draw a vertical line ⑤ up to the scale representing the heating coil capacity (16 kW).
- Water flow. Prolong the line ⑤ down to water discharge axis at the bottom of the graphic ⑥ (0.2 l/s).
- Water pressure drop. Draw the line ⑦ from the point where line ⑥ crosses the black curve to the pressure drop axis. (2.1 kPa).

VENTS MPA W

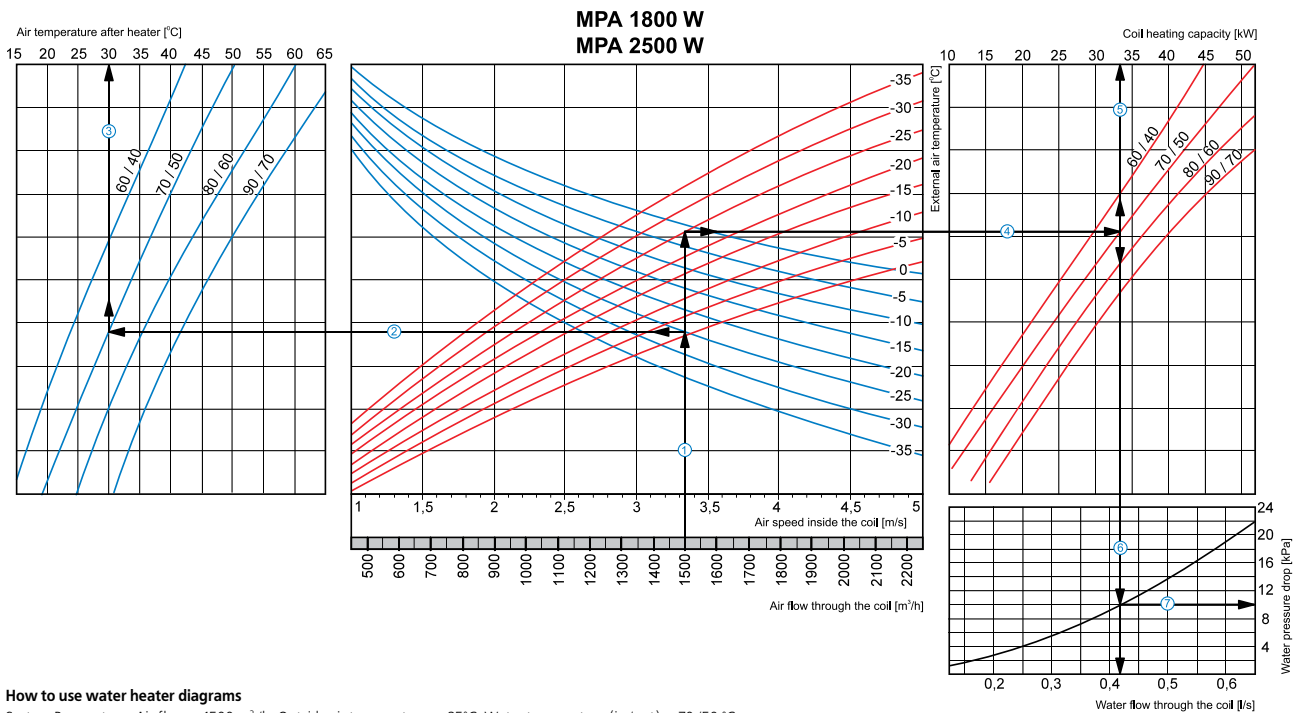

How to use water heater diagrams

System Parameters: Air flow = 1500 m³/h. Outside air temperature = 25°C. Water temperature (in/out) = 70/50°C.

- Air Speed. Starting from 1500 m³/h on the air flow scale draw a vertical line ① till the air speed axis which makes about (3.3 m/s).
- Supply air temperature. Prolong the line ① up to the point where it crosses the outside air temperature (blue curve), e.g. 25°C; then draw a horizontal line ② from this point to the left till crossing water in/out temperature curve (70/50°C). From this point draw a vertical line ③ to the supply air temperature axis on top of the graphic (+30°C).
- Heating coil capacity. Prolong the line ① up to the point where it crosses the outside air temperature 25°C (red curve) and draw a horizontal line ④ from this point to the right until it crosses water in/out temperature curve (70/50°C), from here draw a vertical line ⑤ up to the scale representing the heating coil capacity (33.0 kW).
- Water flow. Prolong the line ⑤ down to water discharge axis at the bottom of the graphic ⑥ (0.42 l/s).
- Water pressure drop. Draw the line ⑦ from the point where line ⑥ crosses the black curve to the pressure drop axis. (10.0 kPa).

Hot water coil parameters:

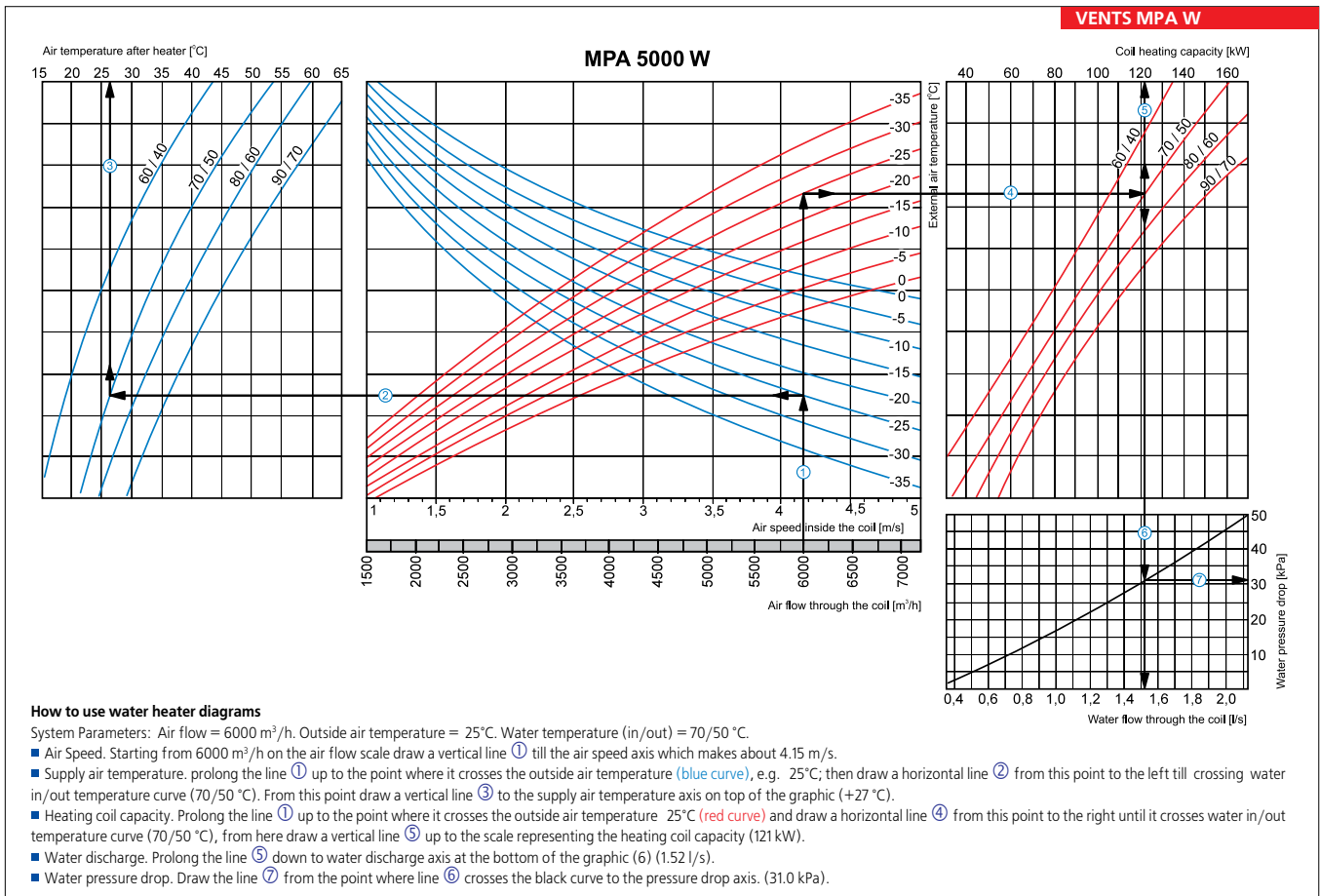
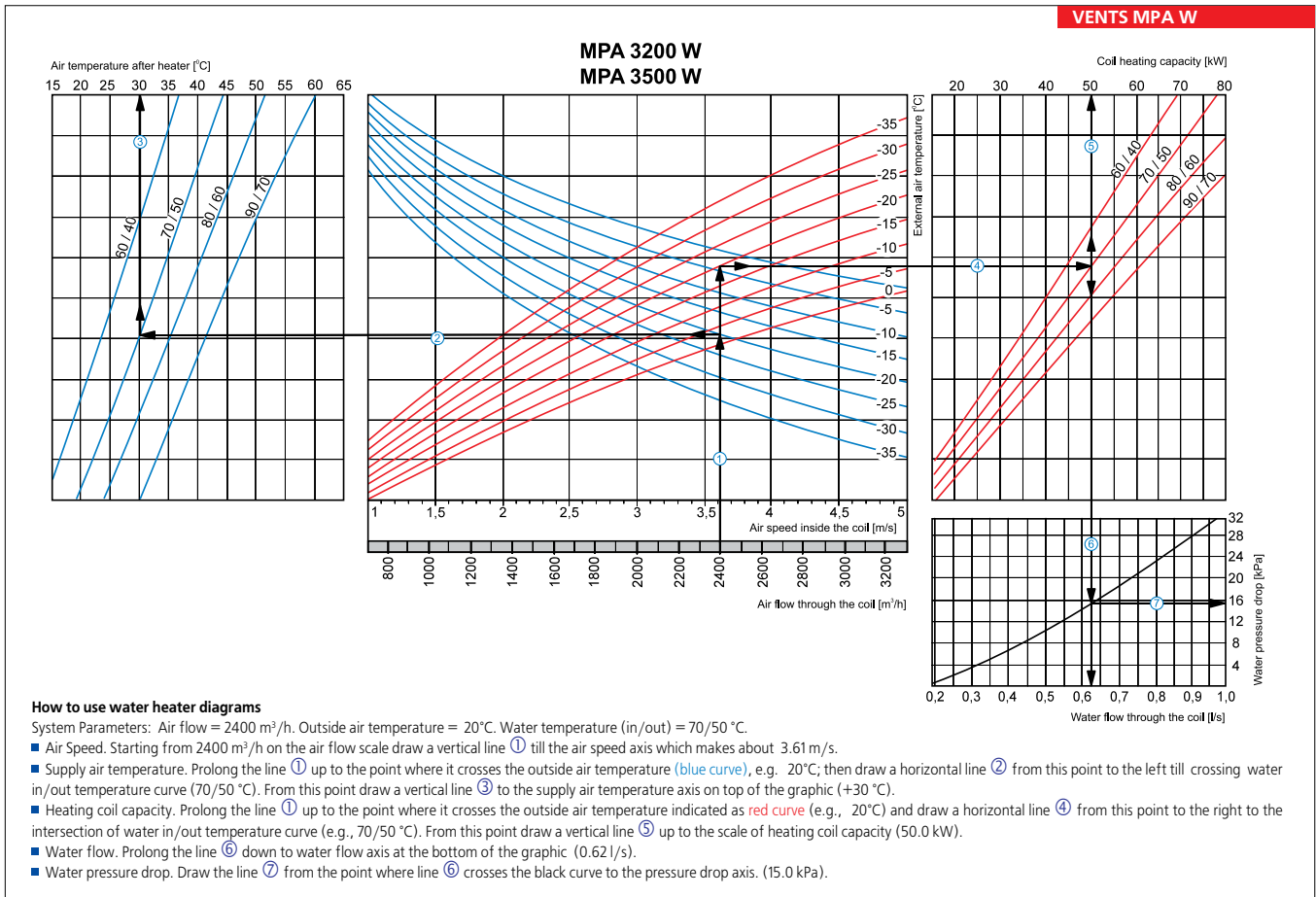

Series
VENTS PA...E



Suspended air supply units with the air capacity up to **3350 m³/h** in the sound and heat insulated casing with the electric heater

Series
VENTS PA...W



SAS908 control panel

Suspended air supply units with the air capacity up to **4100 m³/h** in the sound and heat insulated casing with the water heater

■ **Description**

Supply unit PA is a complete ventilation unit to provide air filtration, heating and fresh air supply to the premises. To ensure the balanced ventilation VA exhaust unit which has the same fans as PA unit can be connected to PA exhaust unit. VA unit shall operate in coordination with PA unit.

■ **Casing**

The casing is made of aluminum zinc steel plates with 50 mm thermal and sound insulating layer made of mineral wool.

■ **Filter**

The units are supplied with built in G4 panel filter for supply air filtration. F7 filter is available as an option.

■ **Heater**

PA units are equipped both with electrical (PA...E) and water (PA...W) heaters. Depending upon the power required 2, 3 or 4 rows of water coils are installed.

■ **Fan**

The unit is equipped with the direct driven plug fan incorporating the high pressure centrifugal impeller with the backward curved blades driven by the external rotor motor. Such fan configuration ensures the best operating characteristics as air capacity, noise level and efficiency. The fan can be easily removed from the casing for inspection and cleaning.

■ **Mounting**

The unit is designed for indoor installation either on the floor, on the wall or under the ceiling by means of a seat angle with inserted vibration damping element or attached to a wall with brackets. The unit can be mounted either in service spaces or in main premises above the suspended ceiling, in the pocket or the unit can be placed directly in the room. All the electrical connections are performed through the terminal box placed in the connection box. PA supply units are supplied with the fastening brackets to facilitate mounting. The unit can be mounted in any position but the vertical one with vertical air

downstream because the electrical heating elements are not allowed under the fan. Access for the unit maintenance and filter cleaning shall be provided.

■ **Control and automation**

The supply units are available in two modifications:

1. No control system. Customer defined and customer selected automation system.
2. Integrated control and automation system ensure control of air capacity for 3 speeds, setting temperature of supply air, filter clogging etc. In addition, the automation system provides heating elements overheating protection for PA...E modification. Remote control of the unit is effected by means of the external wire control panel.

Remote control panel provides:

- ▶ ventilation unit remote on/off switching;
- ▶ setting the required air capacity;
- ▶ setting the expected air supply temperature;
- ▶ displaying indoor temperature;
- ▶ failure (alarm) indication.

Remote control panel provides:

- ▶ ventilation unit remote on/off switching;
- ▶ setting the required air capacity;
- ▶ setting the expected air supply temperature;
- ▶ displaying indoor temperature;
- ▶ failure (alarm) indication.

PA 04 W2, PA 04 W3 supply units have no control panel.

Designation key: _____

Series	Unit standard size	Heater type	Row number of the heater
VENTS PA	01; 02; 03; 04	E – electrical; W – water	2 – two rows; 3 – three rows; 4 – four rows

Offered options to the units



page 31

page 31

■ PA...E control and protection functions

- ▶ safe remote start up and shutdown of the unit;
- ▶ setting and maintaining the desired temperature of the supply air with the control panel (electric air heating element control by means of the optosymistor);
- ▶ fan speed control by means of the control panel;
- ▶ trying out of the required patterns during the unit switching on and off;
- ▶ unit timer dependent operation;
- ▶ active electric heating elements overheating protection;
- ▶ disabling the electric heater operation when the motor is not running;
- ▶ electric heater overheating protection by means of two thermostats;
- ▶ filter clogging control (differential pressure sensor).

■ PA...W control and protection functions

The regulating stations designed for systems with cooling coils are additionally equipped with the room temperature sensor. Components of the heater manifold (pump, valve with actuator etc.) are not included in the equipment list.

■ Functionality

1. Automatic control of RRVA air flow regulating damper.
2. Filter clogging control and indication.
3. Smooth fan speed control (3 380 V at 50 Hz).
4. Maintaining the set temperature of supply air or indoor air temperature.
5. Water heating coils operation control.
6. Control of compressor condenser block (CCB) for systems supplied with freon cooling coils.

7. Exhaust fan startup signal.

8. Individual adjustability of all parameters for ventilation system.
9. Unit shutdown on a signal from fire alarm panel.

■ Supplementary equipment

The unit can be equipped with the air flow regulating damper, flexible connectors (or clamps) and mixing set for models with the water heating coils and the cooling coils to be installed in the air duct after PA unit.

Unit overall dimensions:

Type	Dimensions, [mm]								
	B	B1	B2	B3	H	H1	H2	L	L1
PA 01 E	400	420	624	582	200	220	374	1145	1106
PA 02 E	500	520	689	646	300	320	447	1250	1212
PA 03 E	600	620	888	744	350	370	500	1252	1212
PA 01 W	400	420	624	582	200	220	374	1145	1106
PA 02 W	500	520	689	646	300	320	447	1250	1212
PA 03 W	600	620	787	744	350	370	500	1252	1212
PA 04 W	700	720	888	844	400	420	546	1302	1262

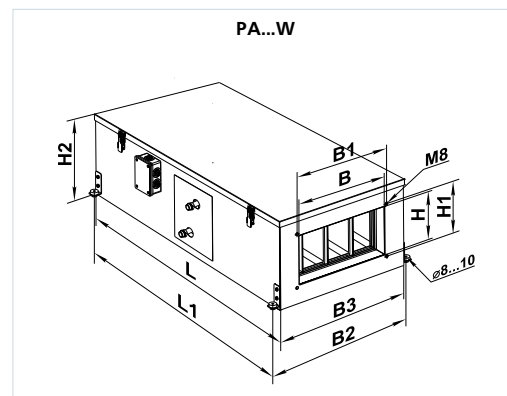
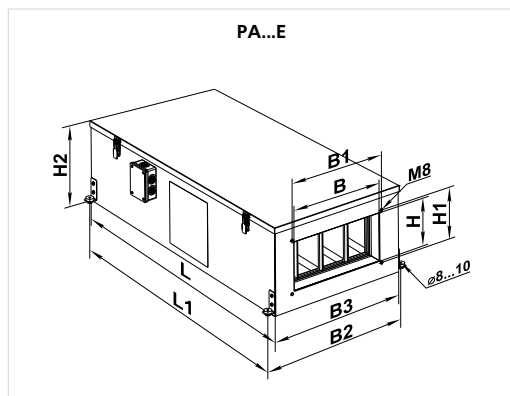

SUPPLY UNITS

Technical data:

	PA 01 E	PA 01 W2	PA 01 W4	PA 02 E	PA 02 W2	PA 02 W4
Unit supply voltage [V / 50 Hz]		3~ 400			3~ 400	
Maximum fan power [W]		320			620	
Fan current [A]		0,55			1,05	
Electric heater capacity [kW]	12,0			18,0		
Electric heater current [A]	17,4			26,0		
Number of water (glycol) coil rows		2	4		2	4
Total power of the unit [kW]	12,32	0,32		18,62	0,62	
Total current of the unit [A]	17,95	0,55		27,05	1,05	
Air capacity [m ³ /h]	1275	1200		2500	2350	
RPM		2700			2690	
Noise level at 3m [dB(A)]		51			54	
Operating temperature [°C]		25 up to +55			25 up to +45	
Casing material		aluzink			aluzink	
Insulation		50 mm, mineral wool			50 mm, mineral wool	
Filter	panel filter G4	G4 (F7) pocket type*		panel filter G4	G4 (F7) pocket type*	
Connected air duct size [mm]		400x200			500x300	
Weight, [kg]	56	55	57	61	61	63

*option

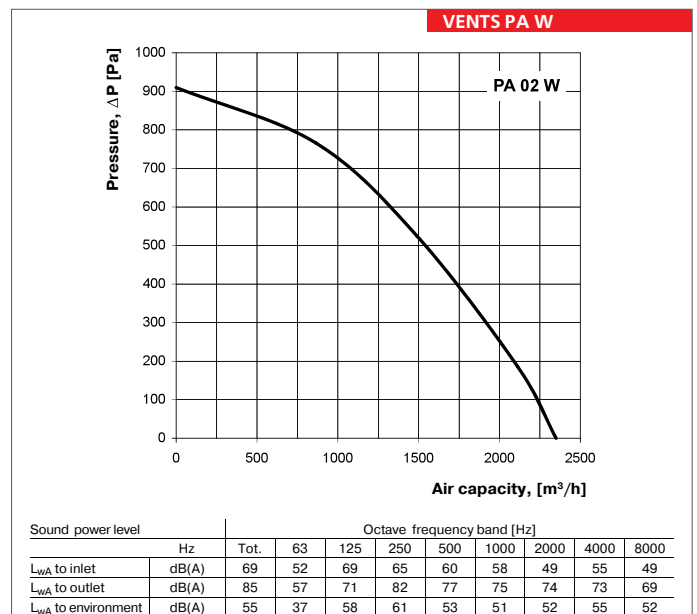
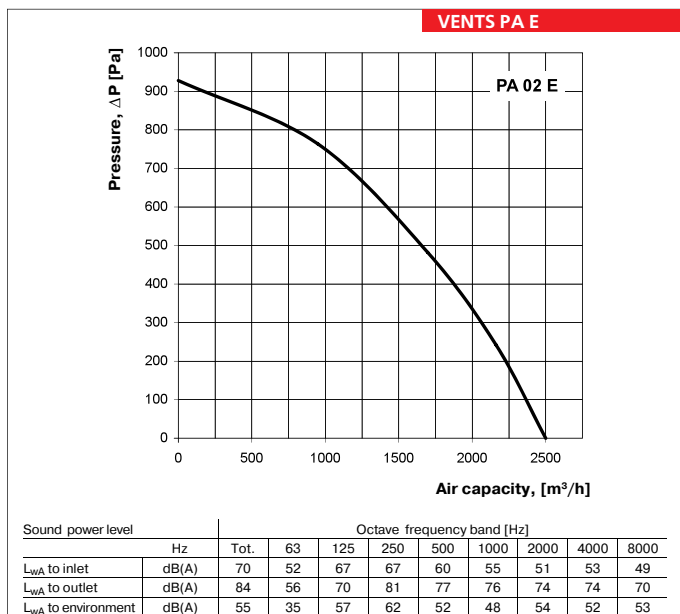
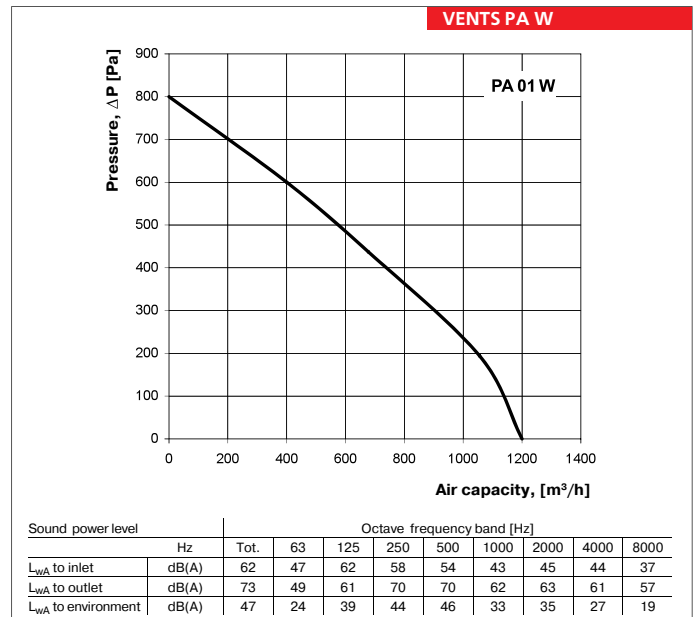
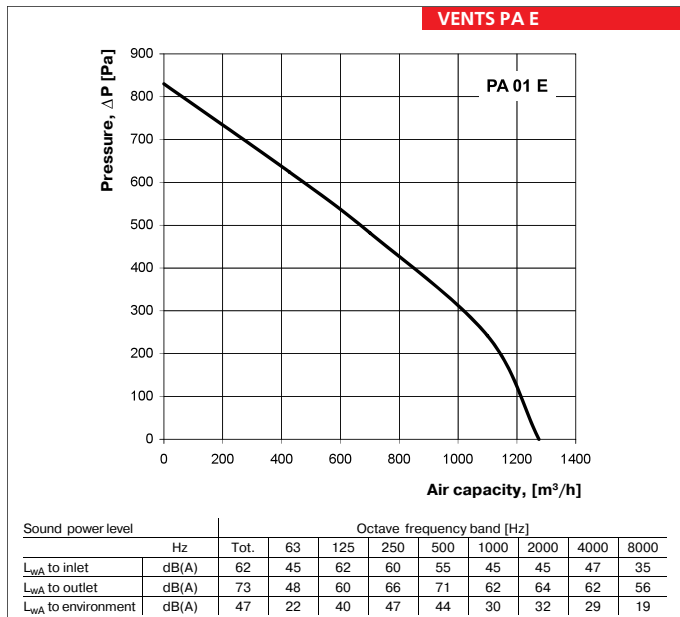

Technical data:

	PA 03 E	PA 03 W2	PA 03 W4	PA 04 W2	PA 04 W3
Unit supply voltage [V / 50 Hz]		3~ 400			3~ 400
Maximum fan power [W]		1330			2300
Fan current [A]		2,4			4,3
Electric heater capacity [kW]	21,0				
Electric heater current [A]	30,0				
Number of water (glycol) coil rows		2	4	2	3
Total power of the unit [kW]	22,33		1,33		2,30
Total current of the unit [A]	32,4		2,4		4,3
Air capacity [m³/h]	3350		3260		4100
RPM		2730			2840
Noise level at 3m [dB(A)]		57			58
Operating temperature [°C]		25 up to +45			25 up to +70
Casing material		aluzink			aluzink
Insulation		50 mm, mineral wool			50 mm, mineral wool
Filter	panel filter G4	G4 (F7) pocket type*			G4 (F7) pocket type*
Connected air duct size [mm]		600x350			700x400
Weight, [kg]	91	91	94	107	110

*option

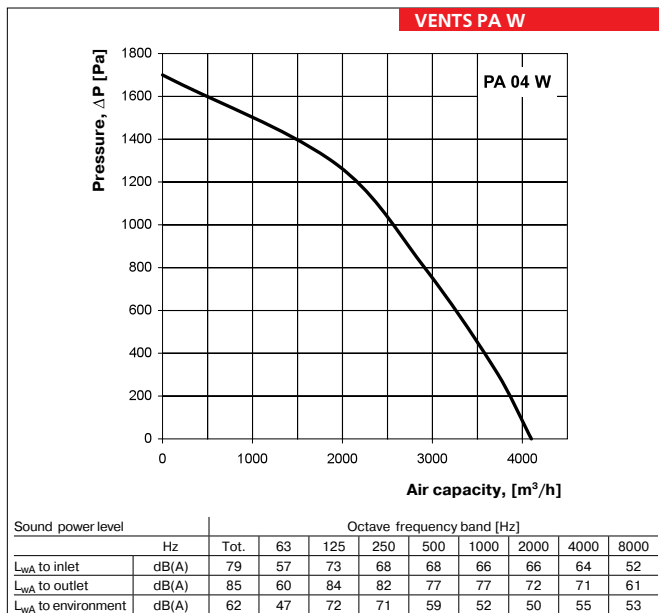
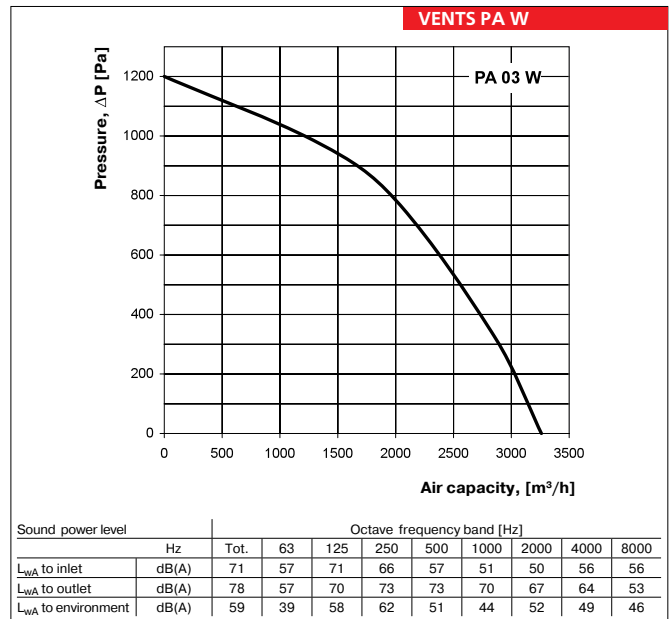
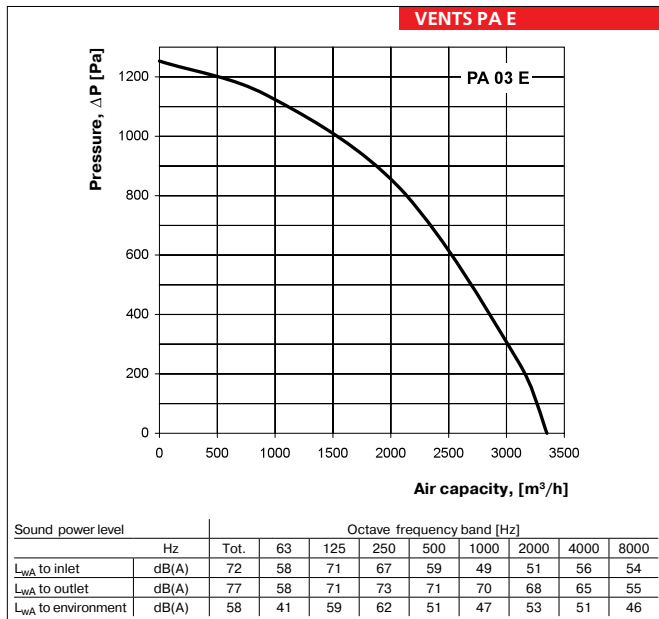

Accessories to supply units:

Type	G4 replaceable filter	F7 replaceable filter	Filter type
PA 01 E	SF PA/WA 01 E G4		panel filter
PA 02 E	SF PA/WA 02 E G4		panel filter
PA 03 E	SF PA/WA 03 E G4		panel filter
PA 01 W2	SFK PA 01 W G4	SFK PA 01 W F7	pocket filter
PA 01 W4			
PA 02 W2	SFK PA 02 W G4	SFK PA 02 W F7	pocket filter
PA 02 W4			
PA 03 W2	SFK PA 03 W G4	SFK PA 03 W F7	pocket filter
PA 03 W4			
PA 04 W2	SFK PA 04 W G4	SFK PA 04 W F7	pocket filter
PA 04 W3			

Hot water coil parameters:

VENTS PA W

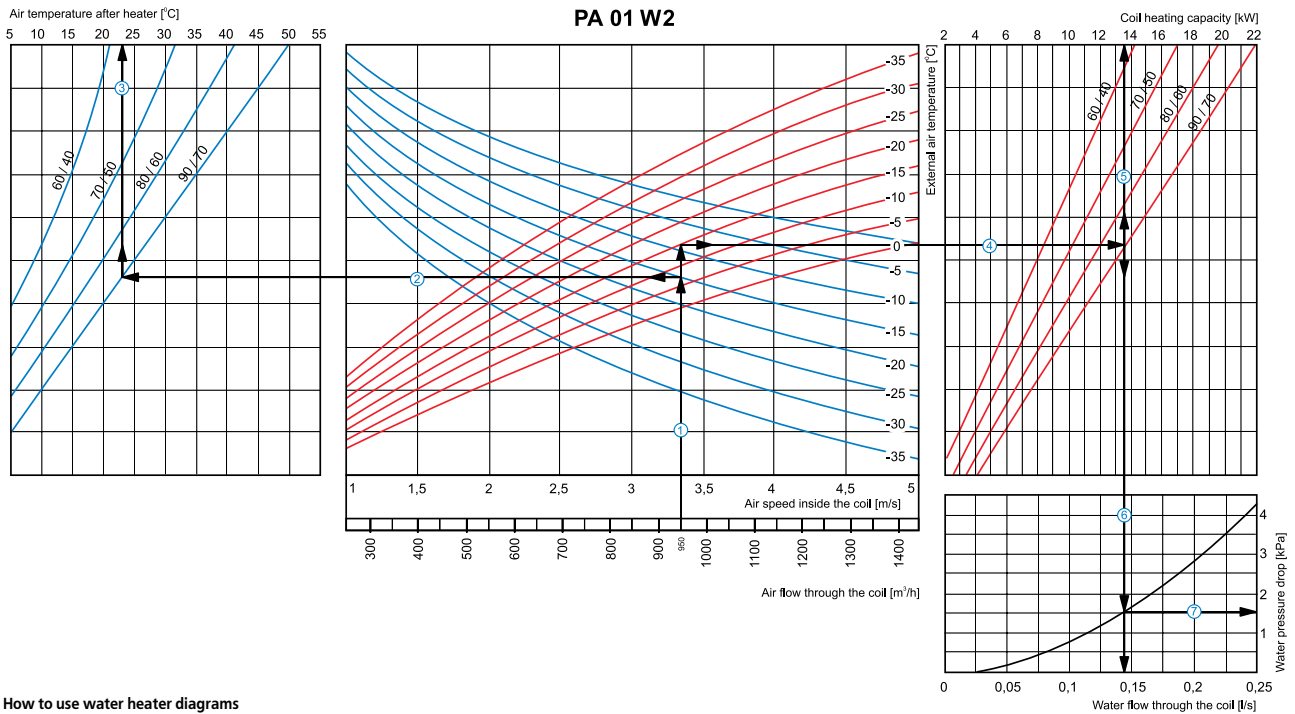

How to use water heater diagrams

System Parameters: Air flow = 950 m³/h. Outside air temperature = 15°C. Water temperature (in/out) = 90/70°C.

- Air Speed. Starting from 950 m³/h on the air flow scale draw a vertical line ① till the air speed axis which makes about 3.35 m/s.
- Supply air temperature. Prolong the line ① up to the point where it crosses the outside air temperature (blue curve, e.g. 15°C); then draw a horizontal line ② from this point to the left till crossing water in/out temperature curve (e.g. 90/70°C). From this point draw a vertical line ③ to the supply air temperature axis on top of the graphic (+23°C).
- Heating coil capacity. Prolong the line ① up to the point where it crosses the outside air temperature (e.g. 15°C, red curve) and draw a horizontal line ④ from this point to the right until it crosses water in/out temperature curve (90/70°C), from here draw a vertical line ⑤ up to the scale representing the heating coil capacity (13.5 kW).
- Water discharge. Prolong the line ⑤ down to water discharge axis at the bottom of the graphic ⑥ (0.14 l/s).
- Water pressure drop. Draw the line ⑦ from the point where the line ⑥ crosses the black curve to the pressure drop axis. (1.5 kPa).

VENTS PA W

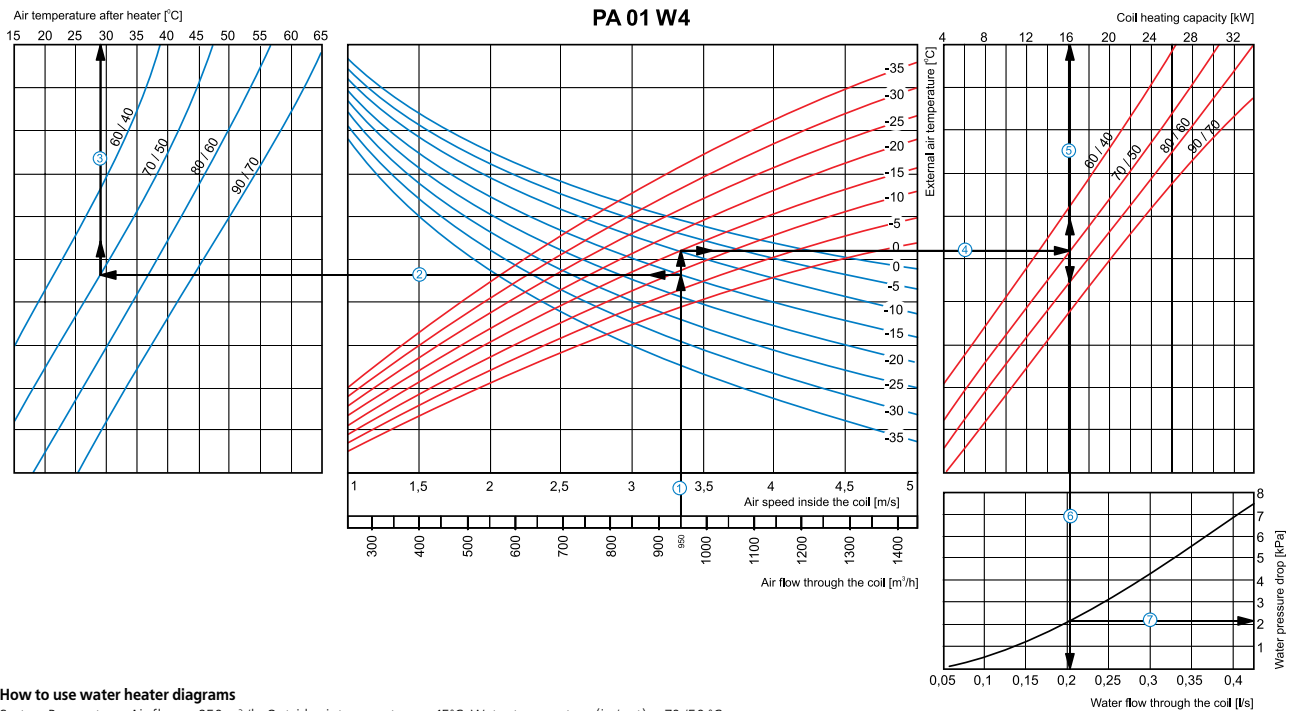

How to use water heater diagrams

System Parameters: Air flow = 950 m³/h. Outside air temperature = 15°C. Water temperature (in/out) = 70/50°C.

- Air Speed. Starting from 950 m³/h on the air flow scale draw a vertical line ① till the air speed axis which makes about 3.35 m/s.
- Supply air temperature. Prolong the line ① up to the point where it crosses the outside air temperature (blue curve, e.g. 15°C); then draw a horizontal line ② from this point to the left till crossing water in/out temperature curve (e.g. 70/50°C). From this point draw a vertical line ③ to the supply air temperature axis on top of the graphic (+29°C).
- Heating coil capacity. Prolong the line ① up to the point where it crosses the outside air temperature (e.g. 15°C, red curve) and draw a horizontal line ④ from this point to the right until it crosses water in/out temperature curve (e.g., 70/50°C), from here draw a vertical line ⑤ up to the scale representing the heating coil capacity (16.0 kW).
- Water discharge. Prolong the line ⑤ down to water discharge axis at the bottom of the graphic ⑥ (0.21 l/s).
- Water pressure drop. Draw the line ⑦ from the point where the line ⑥ crosses the black curve to the pressure drop axis. (2.1 kPa).

Hot water coil parameters:

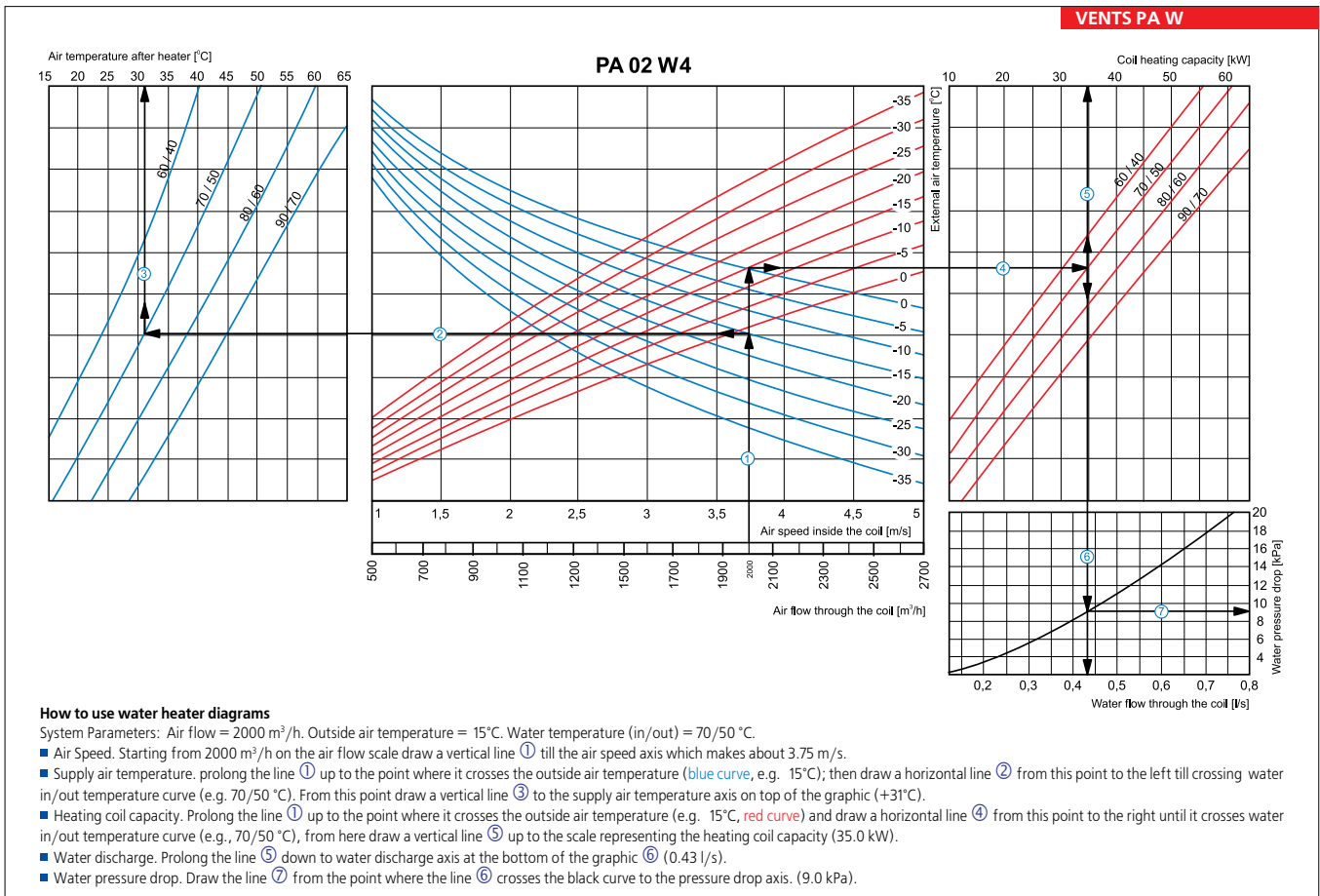
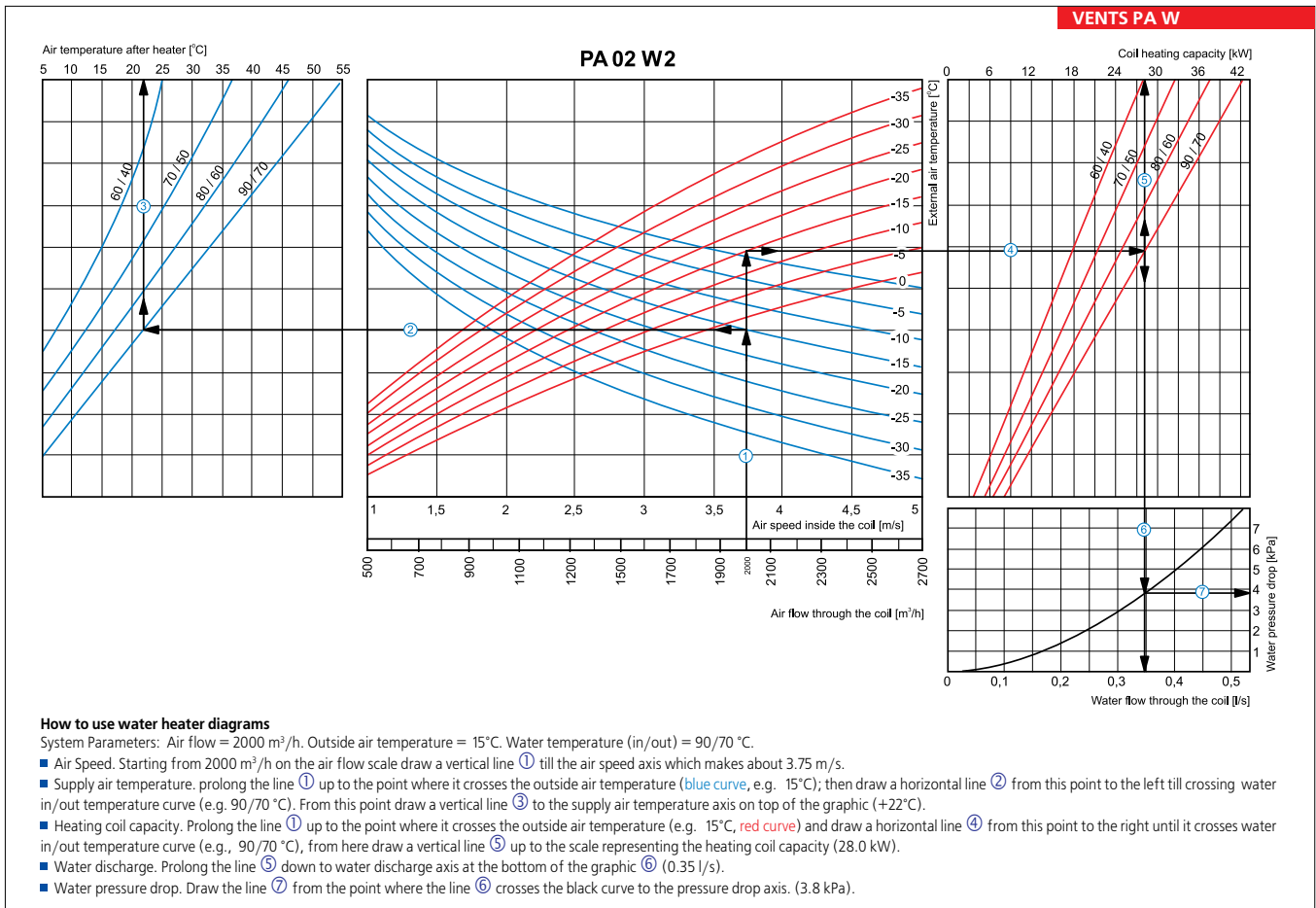

Hot water coil parameters:

VENTS PA W

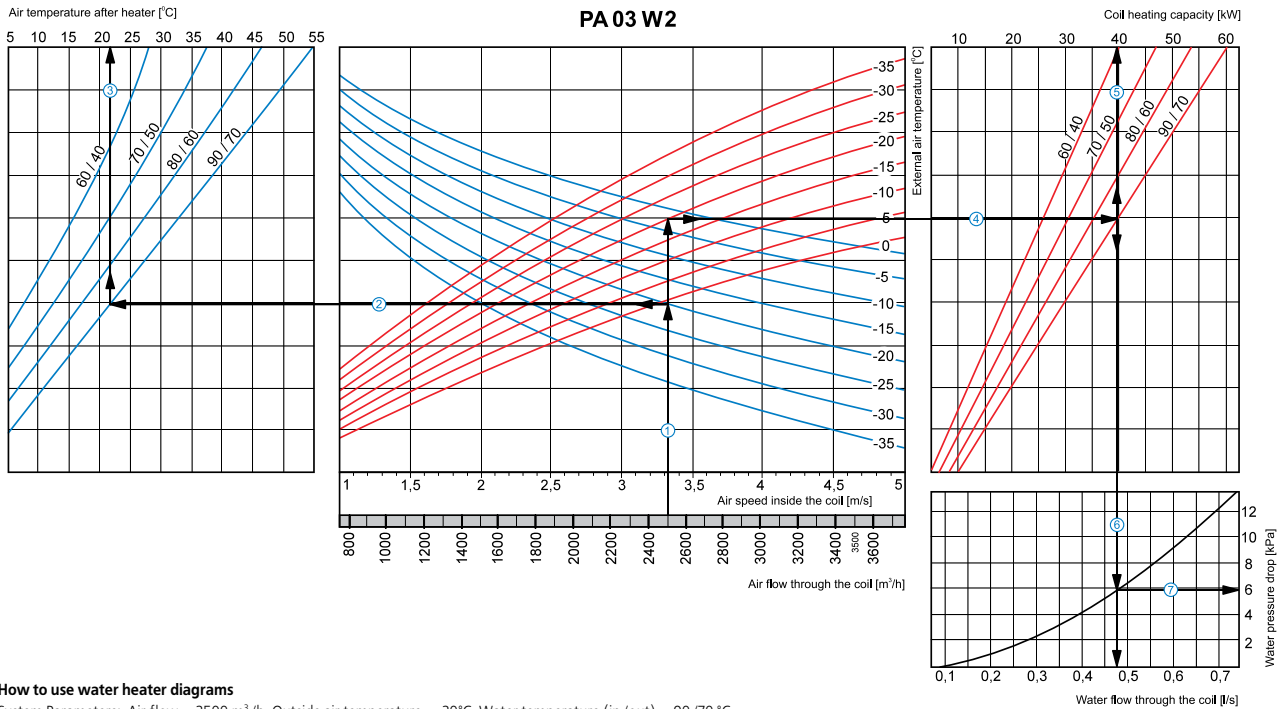

How to use water heater diagrams

System Parameters: Air flow = 2500 m³/h. Outside air temperature = 20°C. Water temperature (in/out) = 90/70 °C.

- Air Speed. Starting from 2500 m³/h on the air flow scale draw a vertical line ① till the air speed axis which makes about 3.32 m/s.
- Supply air temperature. Prolong the line ① up to the point where it crosses the outside air temperature (blue curve, e.g. 20°C); then draw a horizontal line ② from this point to the left till crossing water in/out temperature curve (e.g. 90/70 °C). From this point draw a vertical line ③ to the supply air temperature axis on top of the graphic (+22°C).
- Heating coil capacity. Prolong the line ① up to the point where it crosses the outside air temperature (e.g. 20°C, red curve) and draw a horizontal line ④ from this point to the right until it crosses water in/out temperature curve (e.g., 90/70 °C), from here draw a vertical line ⑤ up to the scale representing the heating coil capacity (40.0 kW).
- Water discharge. Prolong the line ⑤ down to water discharge axis at the bottom of the graphic ⑥ (0.47 l/s).
- Water pressure drop. Draw the line ⑦ from the point where the line ⑥ crosses the black curve to the pressure drop axis. (6.0 kPa).

VENTS PA W

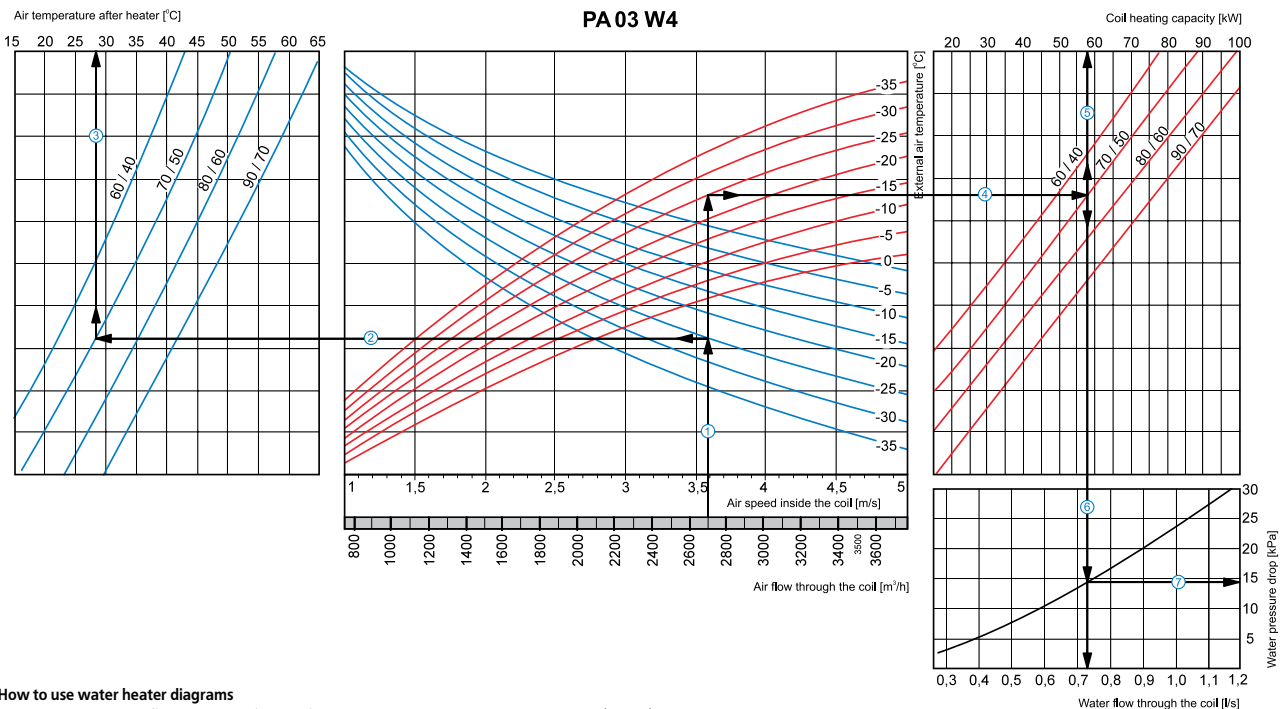

How to use water heater diagrams

System Parameters: Air flow = 2700 m³/h. Outside air temperature = 25°C. Water temperature (in/out) = 70/50 °C.

- Air Speed. Starting from 2700 m³/h on the air flow scale draw a vertical line ① till the air speed axis which makes about 3.59 m/s.
- Supply air temperature. Prolong the line ① up to the point where it crosses the outside air temperature (blue curve, e.g. 25°C); then draw a horizontal line ② from this point to the left till crossing water in/out temperature curve (e.g. 70/50 °C). From this point draw a vertical line ③ to the supply air temperature axis on top of the graphic (+28°C).
- Heating coil capacity. Prolong the line ① up to the point where it crosses the outside air temperature (e.g. 25°C, red curve) and draw a horizontal line ④ from this point to the right until it crosses water in/out temperature curve (e.g., 70/50 °C), from here draw a vertical line ⑤ up to the scale representing the heating coil capacity (58.0 kW).
- Water discharge. Prolong the line ⑤ down to water discharge axis at the bottom of the graphic ⑥ (0.73 l/s).
- Water pressure drop. Draw the line ⑦ from the point where the line ⑥ crosses the black curve to the pressure drop axis. (14.0 kPa).

Hot water coil parameters:

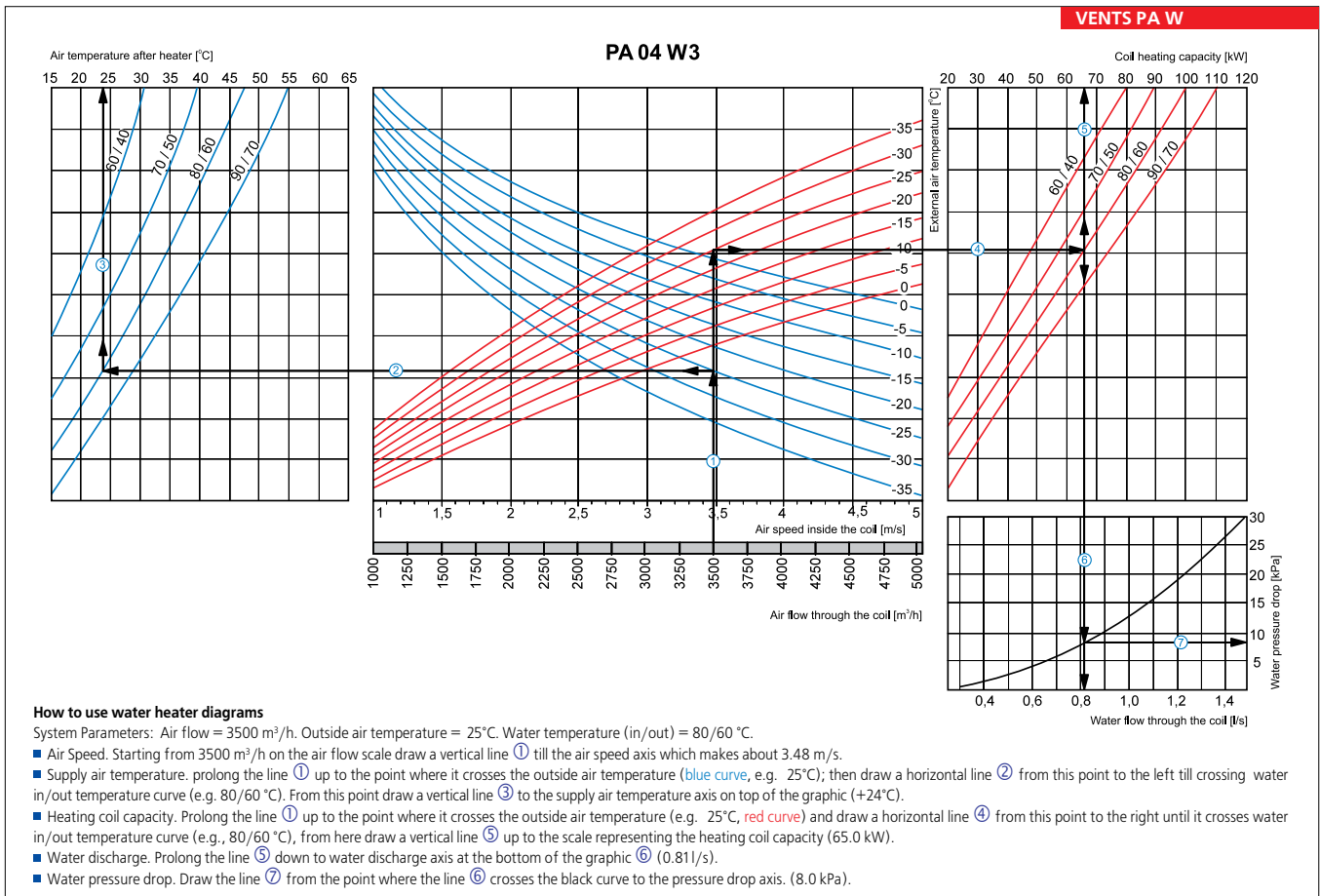
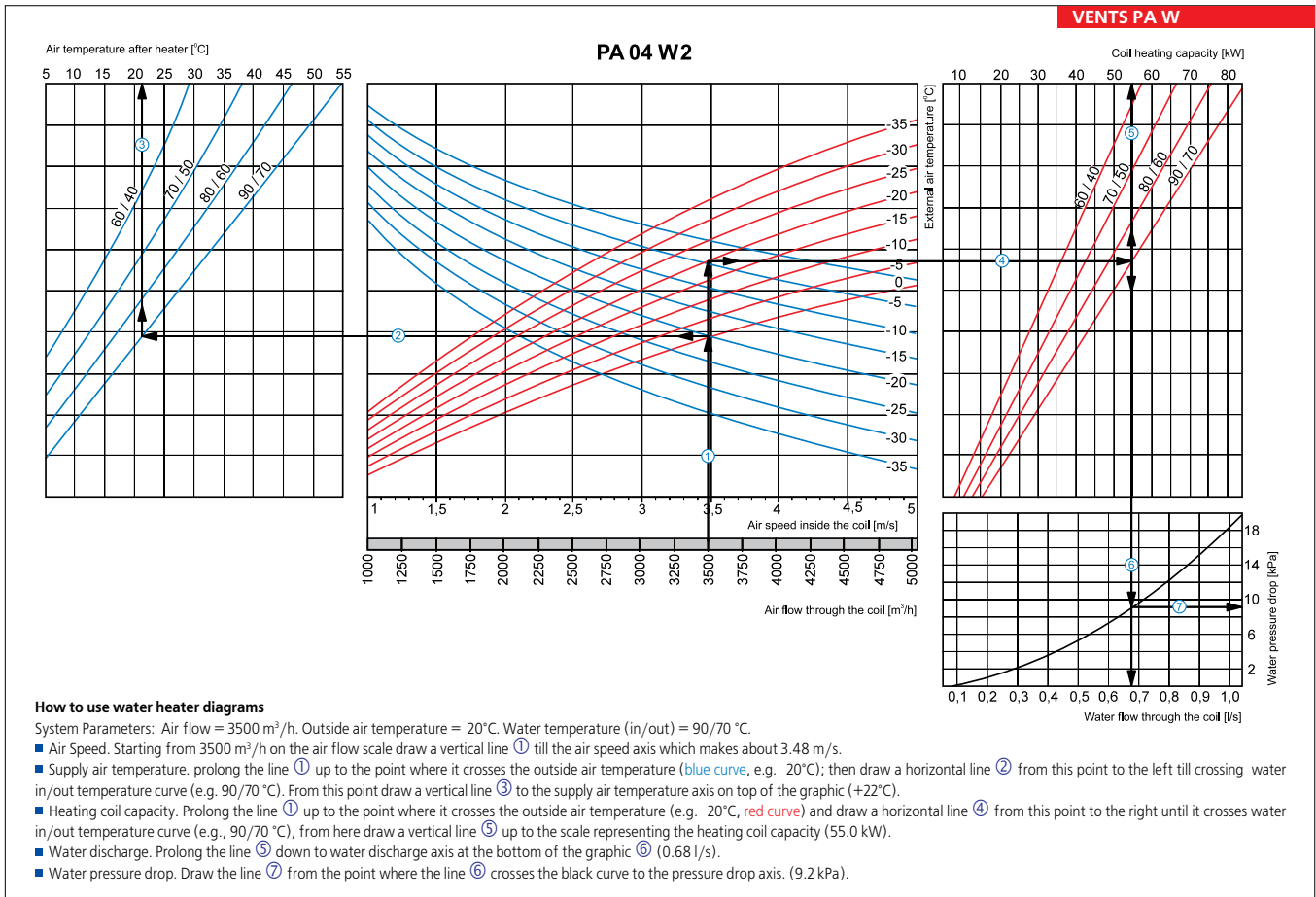

Series
VENTS VA



Compact suspended units with the air capacity up to **4450 m³/h** in the sound insulated casing

■ **Description**

VA exhaust unit is a complete ventilation unit designed for exhaust air extraction from premises. Air capacity up to 4450 m³/h. To ensure balanced ventilation use VA unit together with PA unit. Their joint operation has been checked.

■ **Casing**

The casing is made of aluminum zinc steel plates with 50 mm thermal and sound insulating mineral wool layer.

■ **Fan**

The unit is equipped with direct driven plug fan incorporating high pressure centrifugal impeller with backward curved blades driven by the external rotor motor. Such fan configuration ensures the best operating characteristics as air capacity, noise level and efficiency. The fan can be easily removed from the casing for inspection and cleaning.

■ **Mounting**

VA exhaust units are fitted with mounting brackets for easy installation. The exhaust units are designed either for floor mounting, ceiling mounting by means of seat angles with anti vibration mounts or for wall mounting by means of brackets. The unit can be mounted either in service spaces or in main premises above the suspended ceiling, in the pocket or in the room. All the electrical connections are performed through the terminal block placed in the connection box. The unit air capacity can be controlled by the optional control panel.

■ **Accessories**

The unit can be equipped with the air damper, flexible connectors, air filter.

Unit overall dimensions:

Type	Dimensions, [mm]								
	B	B1	B2	B3	H	H1	H2	L	L1
VA 01	400	420	624	585	200	220	375	660	621
VA 02	500	520	689	646	300	320	450	665	627
VA 03	600	620	787	745	350	370	500	696	657
VA 04	700	720	888	844	400	420	546	805	766

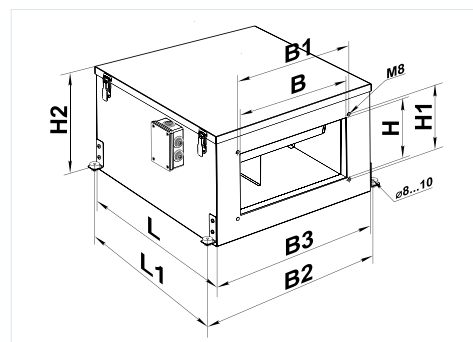

Accessories to supply units:

Type	Replaceable filter	Filter type
VA 01	SF PA/VA 01 E G4	panel filter
VA 02	SF PA/VA 02 E G4	panel filter
VA 03	SF PA/VA 03 E G4	panel filter
VA 04	SF VA 04 E G4	panel filter



Designation key:

Series	Unit standard size
VENTS VA	01; 02; 03; 04

Technical data:

	VA 01	VA 02	VA 03	VA 04
Unit supply voltage [V / 50 Hz]	3~ 400	3~ 400	3~ 400	3~ 400
Maximum fan power [W]	320	620	1330	2300
Fan current [A]	0,55	1,05	2,4	4,3
Air capacity [m ³ /h]	1400	2700	3450	4450
RPM	2700	2690	2730	2840
Noise level at 3m [dB(A)]	51	54	57	58
Operating temperature [°C]	25 up to +55	25 up to +45	25 up to +45	25 up to +70
Casing material	aluzink	aluzink	aluzink	aluzink
Insulation	50 mm, mineral wool		50 mm, mineral wool	
Connected air duct size [mm]	400x200	500x300	600x350	700x400
Weight, [kg]	35	38	59	71

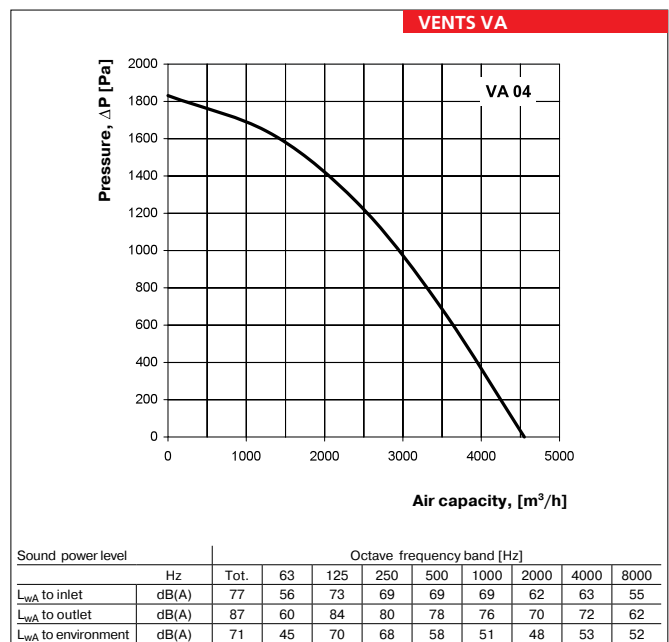
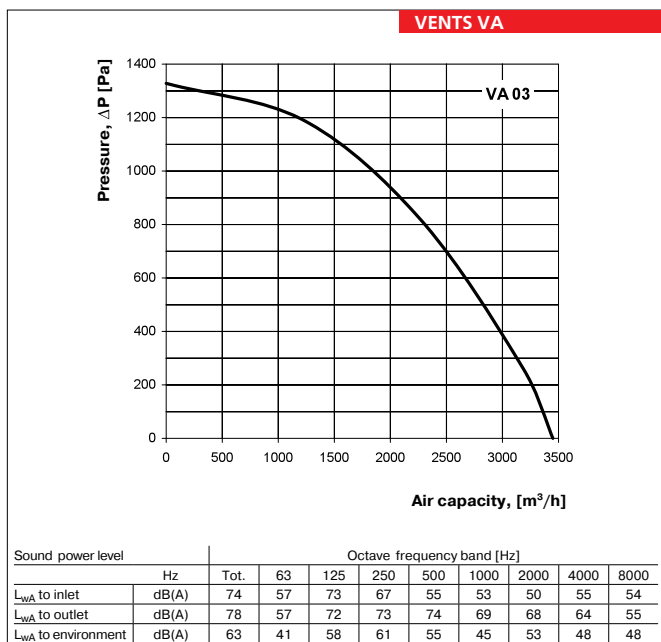
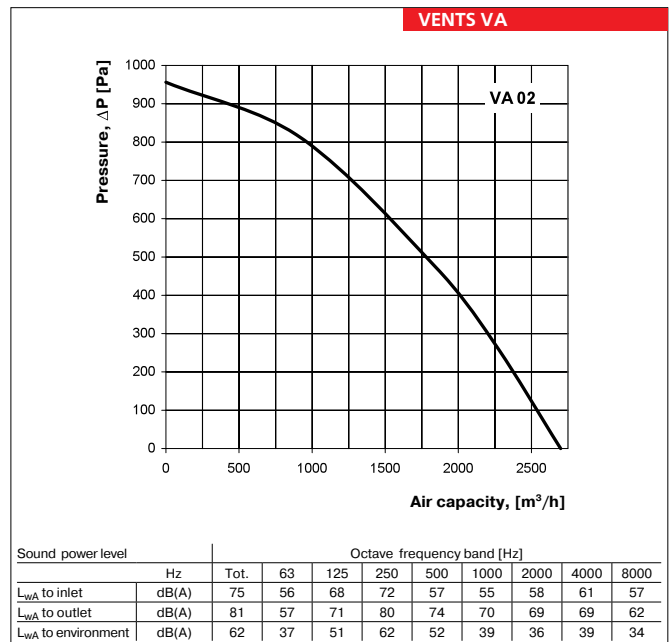
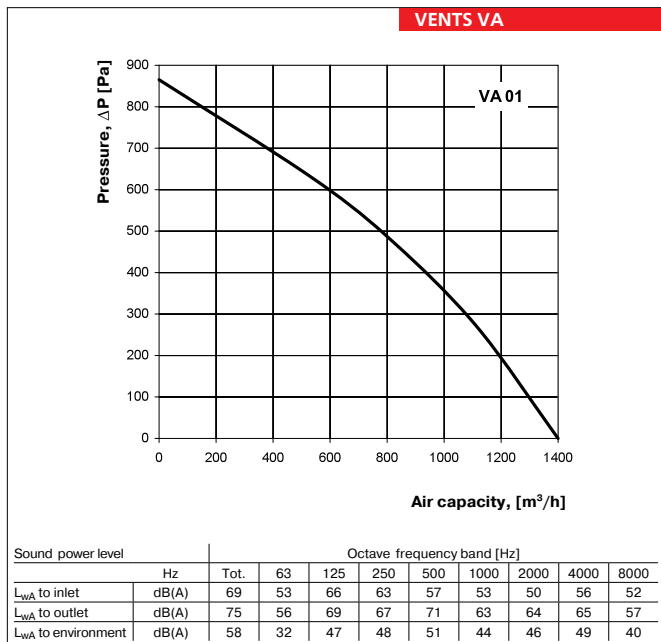

AIR HANDLING UNITS WITH HEAT RECOVERY

▶ VENTS VUT mini Series



▶ Compact sound and heat insulated air handling units with the air capacity up to 345 m³/h and the heat exchanger efficiency up to 85%. Designed to provide supply of fresh filtered air and extract of exhaust air from the premises. Compatible with Ø 100 and 125 mm round air ducts.

▶ VENTS VUT H Series



▶ Sound and heat insulated ventilation units with the air capacity up to 2200 m³/h and the heat exchanger efficiency up to 88%. Designed to provide supply of fresh filtered air and extract of exhaust air from the premises. Compatible with Ø 125, 150, 160, 200, 250, 315 mm round air ducts.

▶ VENTS VUT EH and VUT WH Series



▶ Sound and heat insulated ventilation units with the air capacity up to 2200 m³/h and the heat exchanger efficiency up to 88%. Designed to provide supply of fresh filtered air and extract of exhaust air from the premises. Water heating coils or electric heaters are designed for the unit operation at low outside temperatures. The units are compatible with Ø 125, 150, 160, 200, 250, 315 mm round air ducts.

▶ VENTS VUT PE and VENTS PV Series



▶ Compact suspended sound proof and heat insulated ventilation units with the air capacity up to 4000 m³/h and heat exchanger efficiency up to 90%. Designed to provide supply of fresh filtered air and extract of exhaust air from the premises. Water heating coils or electric heaters are designed for the unit operation at low outside temperatures. The units are compatible with 150, 160, 200, 250, 315 and 400 mm round air ducts.



VENTS VUT mini air handling units with heat recovery

Air capacity up to 300 m³/h

page
40



VENTS VUT mini with EC motor air handling units with heat recovery

Air capacity up to 345 m³/h

page
42



VENTS VUT H air handling units with heat recovery

Air capacity up to 2200 m³/h

page
44



VENTS VUT H with EC motor air handling units with heat recovery

Air capacity up to 600 m³/h

page
48



VENTS VUT EH and VUT WH air handling units with heat recovery

Air capacity up to 2200 m³/h

page
50



VENTS VUT EH and VUT WH with EC motor air handling units with heat recovery

Air capacity up to 600 m³/h

page
56



VUT PE and VUT PV with EC motor air handling units with heat recovery

Air capacity up to 4000 m³/h

page
62

Series
VENTS VUT V mini



Speed controller RS 1 400

Air handling units with the air capacity up to **300 m³/h** in the compact sound and heat insulated casing with vertical duct connections

Series
VENTS VUT H mini



Speed controller RS 1 400

Air handling units with the air capacity up to **300 m³/h** in the compact sound and heat insulated casing with horizontal duct connections

■ **Description**

VUT air handling units mini are the complete ventilation units designed for air filtration, heating and supply to the premises and removal of exhaust air. In the process of operation the heat of the exhausted air is transferred to the supply air through the plate heat exchanger. All the models are compatible with 100 and 125 mm round ducts.

■ **Modifications**

VUT V mini – the models with vertical duct connections, fans with AC motors.

VUT H mini – the models with horizontal duct connections, fans with AC motors.

■ **Casing**

The casing is made of aluzink with 20 mm mineral wool internal heat and sound insulation.

■ **Filter**

Two G4 class built in filters ensure supply and exhaust air filtration.

■ **Fans**

The unit is equipped with supply and exhaust centrifugal fans with backward curved blades and built in thermal overheating protection with automatic restart. The electric motors and the impellers are dynamically balanced in two planes.

■ **Heat exchanger**

The plate heat exchanger is made of aluminium plates. Whenever heat recovery is not required for unit operation the heat exchanger block can be easily replaced by a “summer” block. The unit is also equipped with the drain pan for condensate drainage as well as with built in icing protecting system. During operation of the heat exchanger in the winter time the heat from the warm exhaust air is transferred to the cold supply air. During extract air cooling some condensate can appear. If the temperature of the intake air is below 5°C the condensate can get frozen. To prevent the heat exchanger freezing electronic icing protection system is applied. It switches the supply fan off as the temperature sensor requires.

Warm extract air defrosts the heat exchanger, then the supply fan switches on and the unit continues operating under rated conditions.

■ **Control**

Switching the unit on and its capacity control is performed with thyristor speed controller (PC 1 400) which provides smooth motor speed control over the range of 0-100%.

■ **Mounting**

Air handling unit is mounted on the floor and suspended to the ceiling by means of a seat angle with inserted vibration damping element or attached to a wall with brackets. The unit can be mounted either in service spaces or in main premises above the suspended ceiling, in the pocket or the unit can be placed directly in the room. Mounting position shall provide correct condensate drainage. Access for maintenance and filter cleaning shall be reserved on the side of the removable side panel.

Designation key: _____

Series	Rated air capacity, m ³ /h	Duct connection	Type
VENTS VUT	200; 300	V – vertical duct connection H – horizontal duct connection	mini

Offered options to the units



page 41

page 41

Technical data:

	VUT 200 H mini	VUT 200 V mini	VUT 300 H mini	VUT 300 V mini
Unit supply voltage [V / 50 Hz]	1~ 230		1~ 230	
Maximum fan power [W]	2pcs. x 58		2pcs. x 58	
Fan current [A]	2pcs. x 0,26		2pcs. x 0,26	
Total power of the unit [W]	116		116	
Total current of the unit [A]	0,52		0,52	
Air capacity [m³/h]	200		300	
RPM	2500		2500	
Noise level at 3m [dB[A]]	24 45		28 47	
Operating temperature [°C]	25 up to +50		25 up to +50	
Casing material	aluzink		aluzink	
Insulation	20 mm mineral wool		20 mm mineral wool	
Filter: exhaust / supply	panel filter G4		panel filter G4	
Replaceable filter*	SF VUT mini G4		SF VUT mini G4	
Summer block*	VL VUT mini		VL VUT mini	
Duct connection diameter, [mm]	∅ 100		∅ 125	
Weight, [kg]	30		30	
Recuperation efficiency	up to 85%		up to 85%	
Heat exchanger type	cross flow type		cross flow type	
Heat exchanger material	aluminum		aluminum	

*option

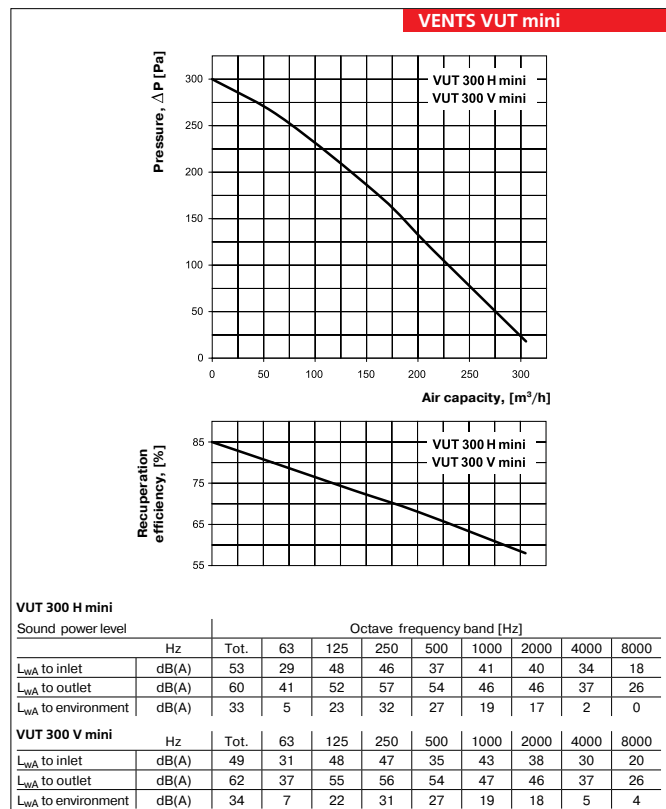
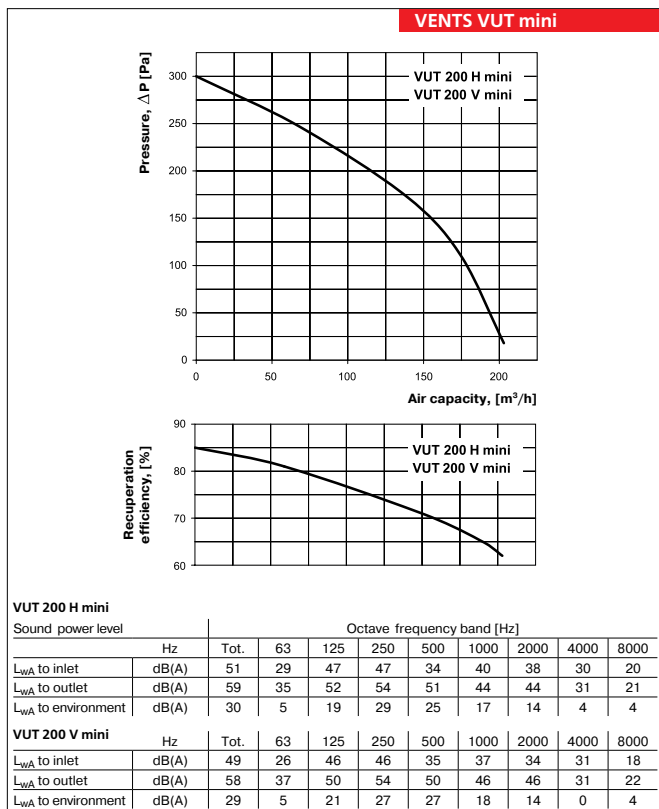

Unit overall dimensions:

Type	Dimensions, [mm]											
	∅D	B	B1	B2	B3	H	H1	H2	H3	L	L1	L2
VUT 200 H mini	99	278	200	121	192	481	431	84	191	699	640	600
VUT 300 H mini	124	278	200	139	139	481	431	89	296	699	640	600

Type	Dimensions, [mm]												
	∅D	B	B1	B2	B3	H	H1	L1	L2	L3	L4	L5	L6
VUT 200 V mini	99	278	200	109	169	481	431	640	600	73,5	204	396	526,5
VUT 300 V mini	124	278	200	100	178	481	431	640	600	74	210	390	526

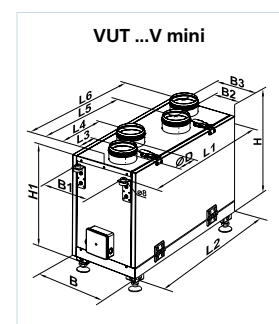
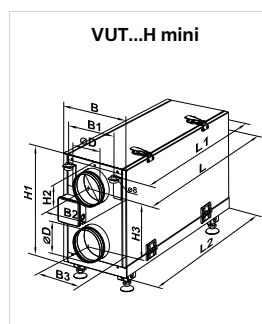

Series
VENTS VUT V mini EC



Speed controller R 1/010



Series
VENTS VUT H mini EC



Speed controller R 1/010



with the high efficiency and perfect control over the whole speed range. Premium efficiency (reaching 90%) is an absolute advantage of electronically commutated motors.

■ **Heat exchanger**

The cross flow air to air plate heat exchanger block is manufactured from aluminum plates. Whenever heat recovery is not required the heat exchanger block can be easily replaced by a "summer" block. The unit is also equipped with the drain pan for condensate drainage as well as built in icing protecting system. Its operating principle is based on switching the supply fan off as the temperature sensor requires. Warm exhaust air heats the heat exchanger. Then the supply fan switches on and the unit continues operating under normal rated conditions.

■ **Control**

The unit is controlled by means of external control signal 0-10 V (e.g., R 1/010 controller for EC motors). Air capacity as a function of temperature level, pressure and smoke conditions and other system parameters. Should the value of the control factor get changed the EC motor changes its speed and the fan boosts as much air volume to the ventilation system as required.

■ **Mounting**

Air handling unit is mounted on the floor and suspended to the ceiling by means of a seat angle with inserted vibration damping element or attached to a wall with brackets. The unit can be mounted either in service spaces as balcony, storeroom, basement, roof space or in main premises above the suspended ceiling, in the pocket or the unit can be placed directly in the room. Mounting in any position shall provide correct condensate drainage. Access for the maintenance shall be reserved at the side of the swing out access cover.

Air handling units with the air capacity up to **345 m³/h** and the recuperation efficiency up to 85% in the compact sound and heat insulated casing with vertical duct connections.

Air handling units with the air capacity up to **345 m³/h** and the recuperation efficiency up to 85% in the compact sound and heat insulated casing with horizontal duct connections.

■ **Description**

VUT mini air handling unit is a complete air handling unit designed for air filtration, heating and supply to the premises and removal of exhaust air. During the operating process the heat of the exhausted air is transferred to the supply air through the plate heat exchanger. Applied in ventilation and conditioning systems for various premises that require economic solution and controllable air exchange. EC motors reduce energy consumption by 1.5-3 times and ensure high efficiency and low noise level at the same time. All the models are compatible with Ø 100 and 125 mm round ducts.

■ **Modifications**

VUT V mini EC series is a range of compact energy saving Air Handling Units (AHU) equipped with intake and exhaust centrifugal fans powered by EC motors, cross flow heat recovery elements and air filters. Vertical duct connections.
VUT H mini EC series is a range of compact energy

saving Air Handling Units (AHU) equipped with intake and exhaust centrifugal fans powered by EC motors, cross flow heat recovery elements and air filters. Horizontal duct connections.

■ **Casing**

The casing is manufactured from aluminum zinc compound with 20 mm thick mineral wool layer for heat and sound insulation.

■ **Filter**

Two incorporated G4 panel filters for intake and supply air filtration are applied in the unit.

■ **Motor**

The impeller with backward curved blades is powered by high efficient electronically commutated (EC) direct current motor. As of today the ventilation system based on heat exchangers is the most state of the art and progressive solution for air exchange organization in the premises. EC motors are featured

Designation key:

Series	Rated air capacity, m ³ /h	Duct connection	Type	Motor type
VENTS VUT	200; 300	V – vertical H – horizontal	mini	EC – electronically commutated synchronous motor

Offered options to the units



page 43

page 43

Technical data:

	VUT 200 H mini EC	VUT 200 V mini EC	VUT 300 H mini EC	VUT 300 V mini EC
Unit supply voltage [V / 50 Hz]	1~ 230		1~ 230	
Maximum fan power [W]	2pcs. x 105		2pcs. x 105	
Fan current [A]	2pcs. x 0,9		2pcs. x 0,9	
Total power of the unit [W]	210		210	
Total current of the unit [A]	1,80		1,80	
Air capacity [m³/h]	240		345	
RPM	3550		3570	
Noise level at 3m [dB(A)]	24 45		28 47	
Operating temperature [°C]	25 up to +60		25 up to +60	
Casing material	aluzink		aluzink	
Insulation	20 mm mineral wool		20 mm mineral wool	
Filter: exhaust / supply	panel filter G4		panel filter G4	
Replaceable filter*	SF VUT mini G4		SF VUT mini G4	
Summer block*	VL VUT mini		VL VUT mini	
Duct connection diameter, [mm]	∅ 100		∅ 125	
Weight, [kg]	30		30	
Recuperation efficiency	up to 85%		up to 85%	
Heat exchanger type	cross flow type		cross flow type	
Heat exchanger material	aluminum		aluminum	

*option

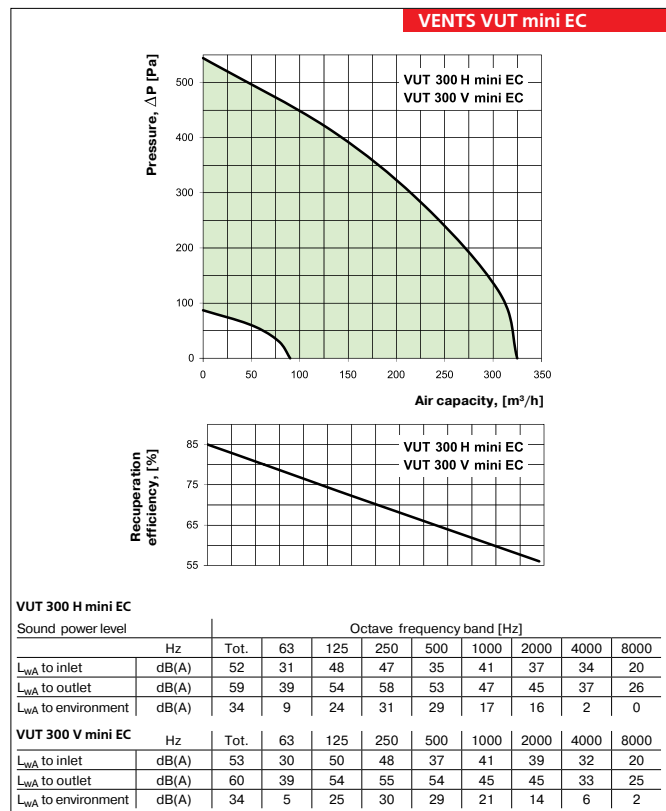
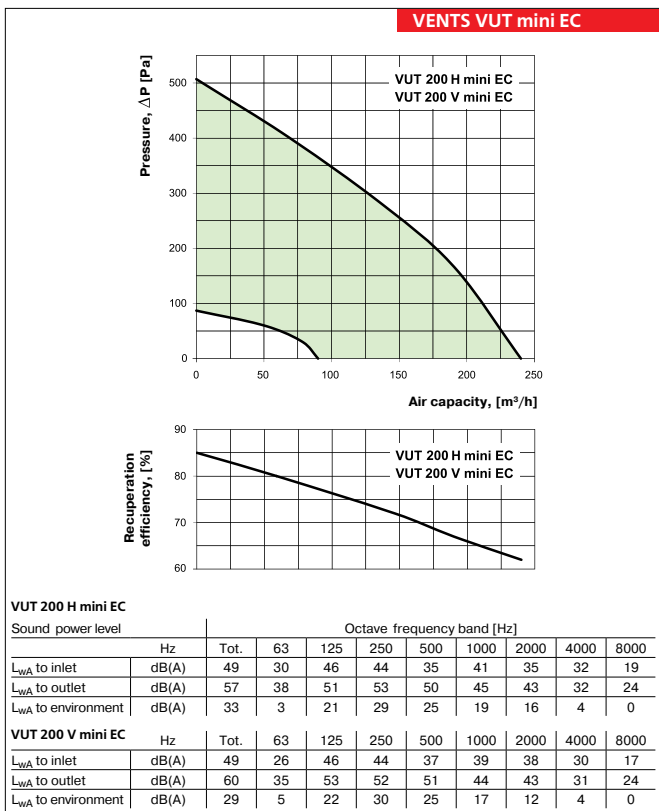

Unit overall dimensions:

Type	Dimensions, [mm]											
	∅D	B	B1	B2	B3	H	H1	H2	H3	L	L1	L2
VUT 200 H mini EC	99	278	200	121	192	481	431	84	191	699	640	600
VUT 300 H mini EC	124	278	200	139	139	481	431	89	296	699	640	600

Type	Dimensions, [mm]												
	∅D	B	B1	B2	B3	H	H1	L1	L2	L3	L4	L5	L6
VUT 200 V mini EC	99	278	200	109	169	481	431	640	600	73,5	204	396	526,5
VUT 300 V mini EC	124	278	200	100	178	481	431	640	600	74	210	390	526

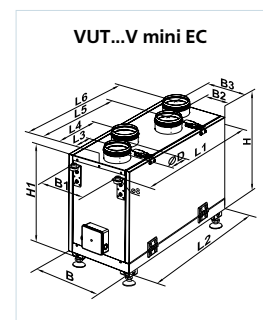
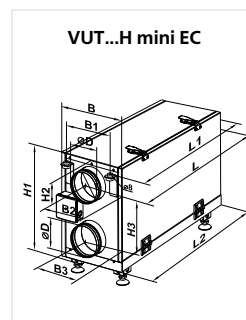

Series
VENTS VUT H



Speed controller P3 1 300

Air handling units with the air capacity up to **2200 m³/h** and the recuperation efficiency up to **88%** in the compact sound and heat insulated casing.

■ **Description**

Air handling unit VUT H is a complete ventilation units designed for air filtration and supply to the premises and exhaust air removal. During the operation process the exhaust air heat is transferred to the supply air through the plate heat exchanger. All the models are designed for connection with Ø 125, 150, 160, 200, 250, 315 mm round ducts.

■ **Casing**

The casing is made of aluminium profile, double skinned with 20 mm mineral wool heat and sound insulating layer.

■ **Filter**

Two incorporated G4 panel filters for exhaust air ventilation and F7 filters for supply air ventilation are supplied with the unit.

■ **Fans**

The unit is equipped with supply and exhaust centrifugal double inlet fans with forward curved blades and built in thermal overheating protection with automatic restart. The electric motors and impellers are dynamically balanced in two planes. The ball bearings used with motors are designed for at least 40 000 hours operation and are maintenance free.

■ **Heat exchanger**

The cross flow air to air heat exchanger block is manufactured from aluminum plates. Whenever heat recovery is not required the heat exchanger block can be easily replaced by a "summer" block. The unit is also equipped with the drain pan for condensate water drainage as well as built in icing protection system. Its operating principle is based on switching the supply fan off as the temperature sensor requires. Warm exhaust air heats the heat exchanger. Then the supply fan switches on and the unit continues operating under normal rated conditions.

■ **Control**

The motor speed is controlled by means of 4 step control switch to select the minimum, average or maximum speed or the unit shutdown.

■ **Mounting**

Air handling unit is mounted on the floor and suspended to the ceiling by means of a seat angle with anti vibration mounts or attached to a wall with brackets. The unit can be mounted either in service spaces or in main premises above the suspended ceiling, in the pocket or can be placed directly in the room. Mounting in any position shall provide correct condensate drainage. Access for the fan maintenance and filter cleaning shall be provided from outside of the side panels.

Accessories to air handling units:

Type	G4 replaceable filter	F7 replaceable filter	Summer block
VUT 350 H	SF VUT 350 600 H G4	SF VUT 350 600 H F7	VL VUT 350 H
VUT 500 H			VL VUT 500 600 H
VUT 530 H			VL VUT 500 600 H
VUT 600 H			VL VUT 500 600 H
VUT 1000 H	SF VUT 1000 H G4	SF VUT 1000 H F7	VL VUT 1000 H
VUT 2000 H	SF VUT 2000 H G4	SF VUT 2000 H F7	VL VUT 2000 H

Designation key:

Series VENTS VUT	Rated air capacity, m ³ /h 350; 500; 530; 600; 1000; 2000	Duct connection H – horizontal
----------------------------	---	--

Offered options to the units



page 44

page 44

Technical data:

	VUT 350 H	VUT 500 H	VUT 530 H
Unit supply voltage [V / 50 Hz]	1~ 230	1~ 230	1~ 230
Maximum fan power [W]	2pcs. x 130	2pcs. x 150	2pcs. x 150
Fan current [A]	2pcs. x 0,60	2pcs. x 0,66	2pcs. x 0,66
Total power of the unit [W]	260	300	300
Total current of the unit [A]	1,2	1,32	1,32
Air capacity [m ³ /h]	350	500	530
RPM	1150	1100	1100
Noise level at 3m [dB[A]]	24 45	28 47	28 47
Operating temperature [°C]	25 up to +55	25 up to +50	25 up to +50
Casing material	aluzink	aluzink	aluzink
Insulation	25 mm mineral wool	25 mm mineral wool	25 mm mineral wool
Filter: exhaust	G4	G4	G4
intake	F7 (EU7)	F7 (EU7)	F7 (EU7)
Duct connection diameter, [mm]	∅ 125	∅ 150	∅ 160
Weight, [kg]	45	49	49
Recuperation efficiency	up to 78%	up to 88%	up to 88%
Heat exchanger type	cross flow type	cross flow type	cross flow type
Heat exchanger material	aluminum	aluminum	aluminum

Technical data:

	VUT 600 H	VUT 1000 H	VUT 2000 H
Unit supply voltage [V / 50 Hz]	1~ 230	1~ 230	1~ 230
Maximum fan power [W]	2pcs. x 195	2pcs. x 410	2pcs. x 650
Fan current [A]	2pcs. x 0,86	2pcs. x 1,8	2pcs. x 2,84
Total power of the unit [W]	390	820	1300
Total current of the unit [A]	1,72	3,6	5,68
Air capacity [m ³ /h]	600	1200	2200
RPM	1350	1850	1150
Noise level at 3m [dB[A]]	32 48	60	65
Operating temperature [°C]	25 up to +55	25 up to +40	25 up to +40
Casing material	aluzink	aluzink	aluzink
Insulation	25 mm mineral wool	50 mm mineral wool	50 mm mineral wool
Filter: exhaust	G4	G4	G4
intake	F7 (EU7)	G4 (F7)*	G4 (F7)*
Duct connection diameter, [mm]	∅ 200	∅ 250	∅ 315
Weight, [kg]	54	85	96
Recuperation efficiency	up to 85%	up to 88%	up to 87%
Heat exchanger type	cross flow type	cross flow type	cross flow type
Heat exchanger material	aluminum	aluminum	aluminum

*option

Unit overall dimensions:

Type	Dimensions, [mm]									
	∅D	B	B1	B2	B3	H	H1	H2	L	L1
VUT 350 H	124	416	300	54	207	603	230	148	722	768
VUT 500 H	149	416	300	54	207	603	230	148	722	768
VUT 530 H	159	416	300	54	207	603	230	148	722	768
VUT 600 H	199	416	300	54	207	603	230	148	722	768
VUT 1000 H	248	548	496	60	213	794	290	200	802	850
VUT 2000 H	313	846	796	235	588	968	360	246	1000	1050

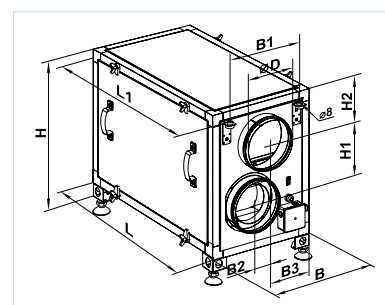

VENTS VUT H

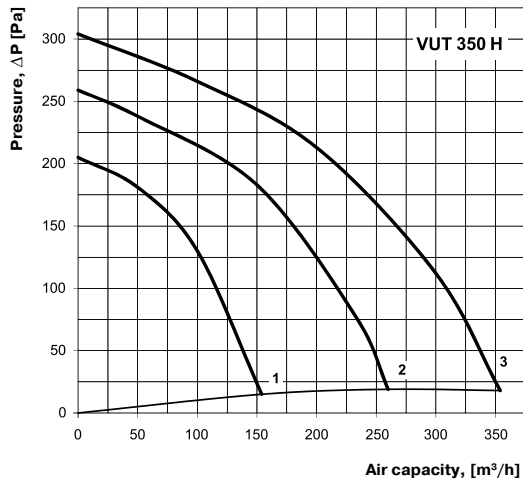

Sound power level	Hz	Octave frequency band [Hz]								
		Tot.	63	125	250	500	1000	2000	4000	8000
L_{WA} to inlet	dB(A)	52	30	48	47	37	43	40	32	20
L_{WA} to outlet	dB(A)	61	39	56	58	53	48	47	37	23
L_{WA} to environment	dB(A)	31	22	23	30	27	21	16	20	22

VENTS VUT H

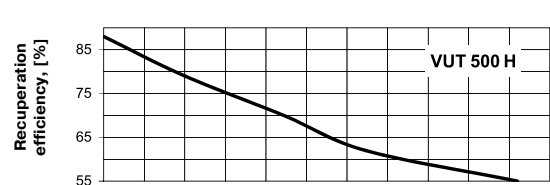
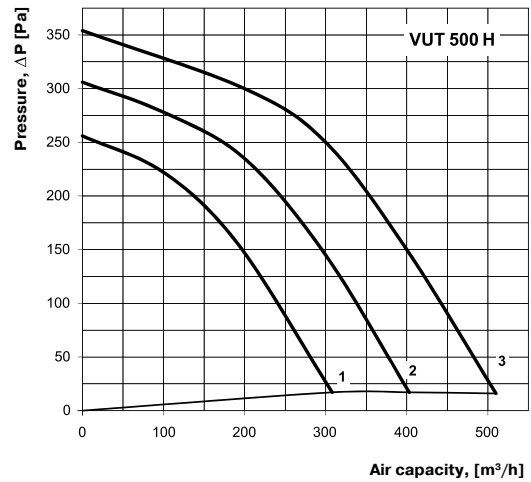

Sound power level	Hz	Octave frequency band [Hz]								
		Tot.	63	125	250	500	1000	2000	4000	8000
L_{WA} to inlet	dB(A)	54	33	49	51	40	45	43	34	22
L_{WA} to outlet	dB(A)	65	41	58	59	55	48	48	39	27
L_{WA} to environment	dB(A)	37	25	26	33	29	20	19	22	23

VENTS VUT H

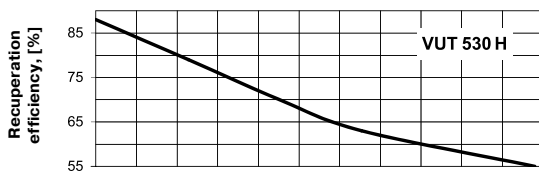
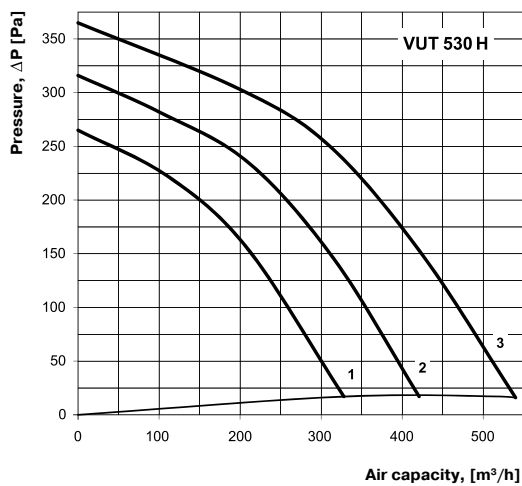

Sound power level	Hz	Octave frequency band [Hz]								
		Tot.	63	125	250	500	1000	2000	4000	8000
L_{WA} to inlet	dB(A)	55	33	51	50	39	46	41	34	21
L_{WA} to outlet	dB(A)	62	43	58	60	57	49	48	38	26
L_{WA} to environment	dB(A)	36	25	26	33	30	20	18	23	25

VENTS VUT H

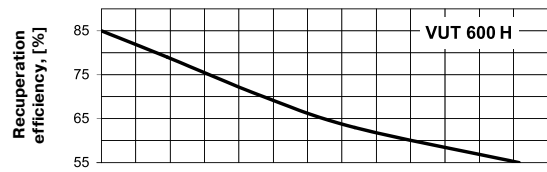
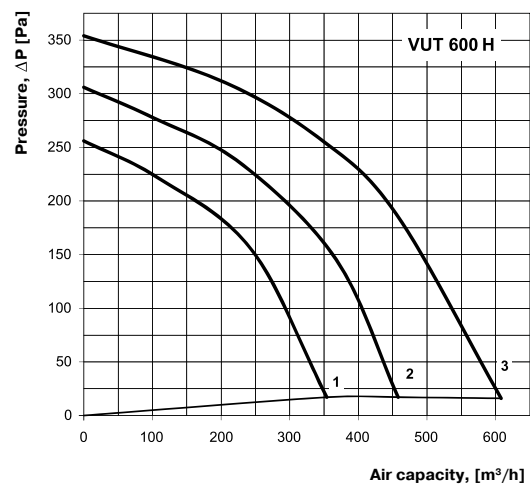

Sound power level	Hz	Octave frequency band [Hz]								
		Tot.	63	125	250	500	1000	2000	4000	8000
L_{WA} to inlet	dB(A)	57	36	53	53	41	48	46	38	25
L_{WA} to outlet	dB(A)	66	44	61	63	59	50	50	39	29
L_{WA} to environment	dB(A)	40	26	29	37	35	25	23	26	27

VENTS VUT H

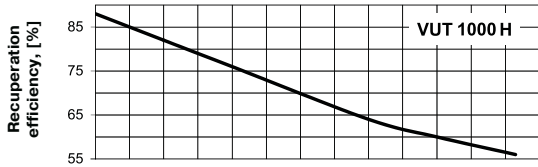
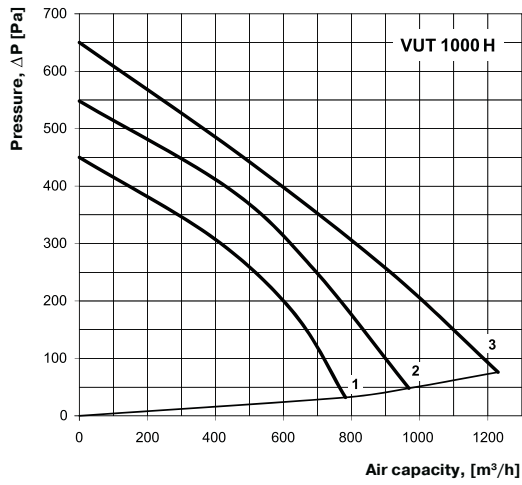

Sound power level	Hz	Octave frequency band [Hz]								
		Tot.	63	125	250	500	1000	2000	4000	8000
L_{WA} to inlet	dB(A)	67	70	66	66	67	63	62	60	56
L_{WA} to outlet	dB(A)	70	70	70	68	68	66	62	59	57
L_{WA} to environment	dB(A)	46	57	54	49	54	39	39	34	32

VENTS VUT H

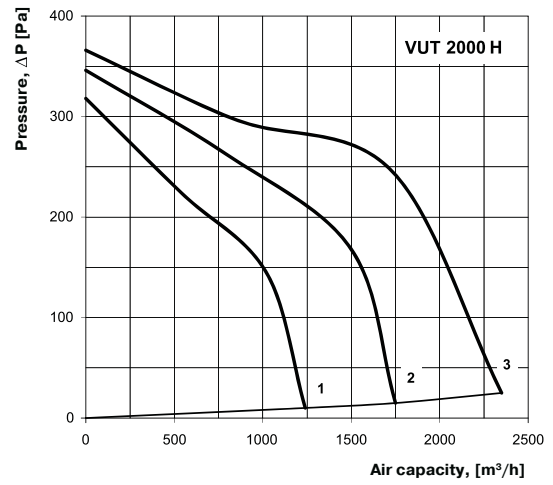

Sound power level	Hz	Octave frequency band [Hz]								
		Tot.	63	125	250	500	1000	2000	4000	8000
L_{WA} to inlet	dB(A)	79	82	83	79	71	70	69	68	60
L_{WA} to outlet	dB(A)	81	82	82	77	72	79	73	74	67
L_{WA} to environment	dB(A)	55	65	66	60	52	49	46	40	38



VUT H unit air exchange example in the flat.

Series
VENTS VUT H EC



Speed controller R 1/010



Air handling units with the air capacity up to **600 m³/h** and recuperation efficiency up to 95% in compact sound and heat insulated casing.

■ **Description**

VUT H air handling unit is a complete air handling unit designed to provide both supply and exhaust ventilation with air filtering and heat recovery. The exhaust air energy is used to heat up the supply fresh air through the heat exchanger. Applied in ventilation and conditioning systems for various premises requiring economic solution and controllable air exchange. EC motors reduce energy consumption by 1.5-3 times and ensure high efficiency combined with low noise level. All the models are designed for connection to 160 and 200 mm round ducts.

■ **Casing**

The casing is made from aluminium profile, double skinned with 20 mm mineral wool heat and sound resistant insulating layer.

■ **Filter**

Two incorporated G4 panel filters for exhaust air ventilation and F7 filters for supply air ventilation are supplied with the unit.

■ **Motor**

The double inlet impellers with backward curved blades are powered by high efficient electronically commutated (EC) external rotor motors. As of today such motor type is the most state of the art and progressive solution for energy saving. EC motors are featured with high efficiency and the best control over the whole speed range. Premium efficiency (reaching 90%) is an absolute privilege of electronically commutated motor.

■ **Heat exchanger**

The cross flow air to air heat exchanger is made of polystyrene plates. Whenever heat recovery is not required the heat exchanger block can be easily replaced by a "summer" block. The unit is also equipped with the drain pan for condensate drainage as well as built in icing protecting system. Its operating principle is based on switching the supply fan off as the temperature sensor requires. Then the supply fan switches on and the unit operates under the rated conditions.

■ **Control**

The unit is controlled by means of external control signal 0-10 V (e.g., R 1/010 speed controller for EC motors). Air capacity control depends on temperature level, pressure and smoke conditions and other system parameters. Should the value of the control factor get changed the EC motor changes its rotation speed accordingly and boosts as much air flow as required for the ventilation system.

■ **Mounting**

Air handling unit is mounted on the floor, suspended to the ceiling by means of a seat angle with inserted vibration damping element or attached to a wall with brackets. The unit can be mounted either in service spaces or in main premises above the suspended ceiling, in the pocket or can be placed directly in the room. Mounting in any position shall provide correct condensation water drainage. Access for maintenance shall be provide through the side panels.

Accessories to air handling units:

Type	G4 replaceable filter	F7 replaceable filter	Summer block
VUT 300 1 H EC VUT 300 2 H EC VUT 400 H EC VUT 600 H EC	SF VUT 300 600 H EC G4	SF VUT 300 600 H EC F7	VL VUT 300 600 H EC

Designation key:

Series	Rated air capacity, m ³ /h	Duct connection	Motor type
VENTS VUT	300; 400; 600	H – horizontal	EC – electronically commutated synchronous motor

Offered options to the units

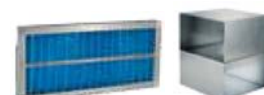

page 48

page 48

Technical data:

	VUT 300 1 H EC	VUT 300 2 H EC	VUT 400 H EC	VUT 600 H EC
Unit supply voltage [V / 50 Hz]	1~ 230		1~ 230	1~ 230
Maximum fan power [W]	2pcs. x 70		2pcs. x 175	2pcs. x 175
Fan current [A]	2pcs. x 0,60		2pcs. x 1,3	2pcs. x 1,3
Total power of the unit [W]	140		350	350
Total current of the unit [A]	1,2		2,6	2,6
Air capacity [m³/h]	300		400	600
RPM	1380		1340	2150
Noise level at 3m [dB(A)]	24 45		28 47	28 47
Operating temperature [°C]	25 up to +60		25 up to +60	25 up to +60
Casing material	aluzink		aluzink	aluzink
Insulation	25 mm mineral wool		25 mm mineral wool	
Filter: exhaust	G4		G4	G4
intake	F7 (EU7)		F7 (EU7)	F7 (EU7)
Duct connection diameter, [mm]	∅ 150	∅ 160	∅ 200	∅ 200
Weight, [kg]	36		37	37
Recuperation efficiency	up to 95%		up to 95%	up to 95%
Heat exchanger type	counter flow		counter flow	counter flow
Heat exchanger material	polystyrene		polystyrene	polystyrene

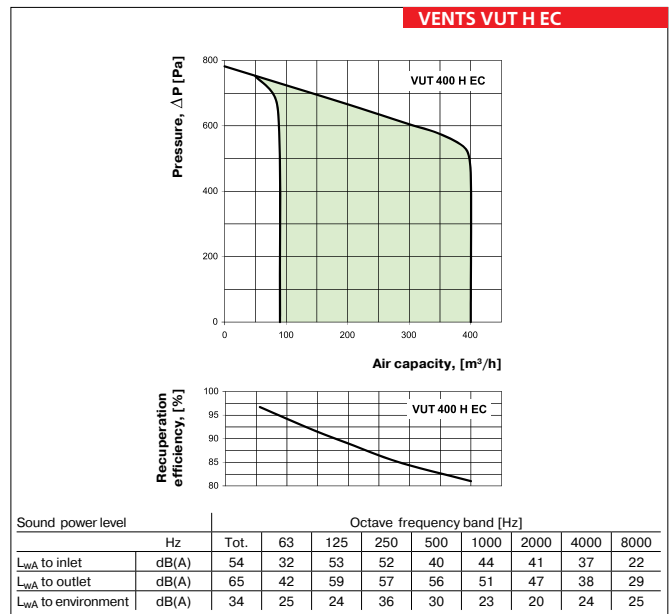
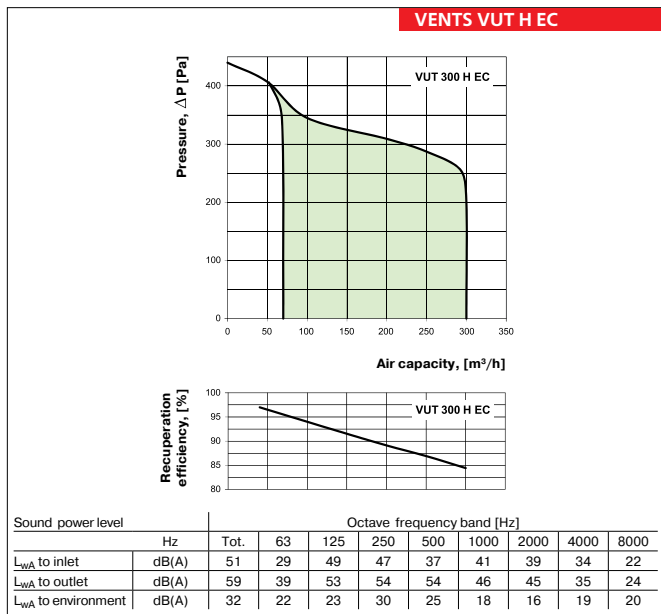

Unit overall dimensions:

Type	Dimensions, [mm]									
	∅D	B	B1	B2	B3	H	H1	H2	L	L1
VUT 300 1 H EC	149	420	390	100	159	562	215	147	829	876
VUT 300 2 H EC	159	420	390	100	159	562	215	147	829	876
VUT 400 H EC	199	420	390	100	159	562	215	147	829	876
VUT 600 H EC	199	420	390	100	159	562	215	147	829	876

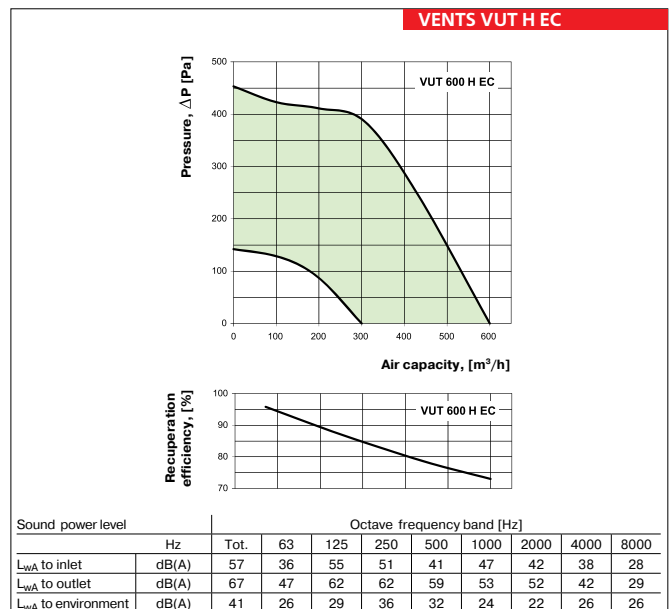
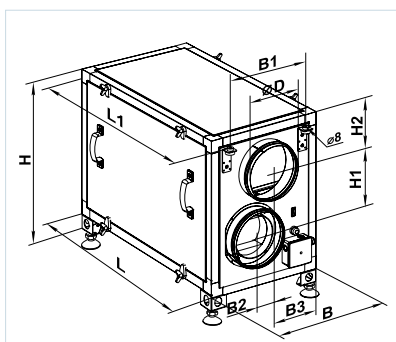

Series
VENTS VUT EH



LCD control panel

Air handling units with the air capacity up to **2200 m³/h** and recuperation efficiency up to 85% in sound proof and heat insulated casing with electric heater.

■ **Description**

Air handling units VUT EH with electric heater and VUT WH with water heater are the complete air handling units designed to provide both supply and exhaust ventilation with air filtering and heat recovery. The exhaust air energy is used to heat up the supply fresh air through the heat exchanger. All the models are designed for connection with Ø 125, 150, 160, 200, 250, 315 mm round ducts.

■ **Modifications**

VUT EH – a range of compact energy saving air handling units (AHU) equipped with supply and exhaust centrifugal fans, cross flow heat recovery elements, electric heating coils and air filters.

VUT WH – a range of compact energy saving air handling units (AHU) equipped with supply and exhaust centrifugal fans, cross flow heat recovery elements, water or glycol heating coils and air filters.

Series
VENTS VUT WH



SAS908 control panel

Air handling units with the air capacity up to **2100 m³/h** and recuperation efficiency up to 78% in sound proof and heat insulated casing with water heater.

■ **Casing**

The casing is manufactured from aluminum zinc compound with 25 mm thick mineral wool heat and sound insulating layer.

■ **Filter**

Two incorporated G4 panel filters for exhaust air ventilation and F7 filters for supply air ventilation are supplied with the unit.

■ **Fans**

The units are equipped with supply and exhaust centrifugal double inlet fans with forward curved blades and built in thermostat with automatic restart. The electric motors and impellers are dynamically balanced in two planes. The ball bearings used with motors are designed for at least 40 000 hours operation and are maintenance free.

■ **Heat exchanger**

The heat exchangers have high efficiency and are manufactured from aluminium plates. The unit is also equipped with the drain pan for condensate drainage.

■ **Heater**

If the external temperature is too low and/or the heat energy transfer from the extract air is insufficient to heat up the incoming air to the required temperature, the heater will automatically be turned on. The control system regulates the heating power to maintain the indoor temperature as set by the user. The units supplied with water heating coils are marked as VUT WH, and the units with electric heaters are marked as VUT EH. Water heating coils are available with two or four rows depending on required heating power.

■ **Automation and control system**

The unit is equipped with built in automation system with multifunctional control panel with graphic LCD indicator. The standard delivery set includes 10 m wire for connection to the control panel. Electronic icing protection is applied to prevent the heat exchanger freezing. It includes the by pass damper and the heater. It operates due to opening of by pass air shutter as the temperature sensor requires to let the air flow pass through the heat exchanger through the by pass duct. During the heat exchanger defrost cycle the supplied air is warmed up in the heater up to the required temperature. During the defrost process the warm exhaust air warms the heat exchanger. After that the by pass damper closes again, the heater is switched off, supply air warms up again through the heat exchanger and the unit continues operating under rated conditions.

■ **VUT EH control and protection functions**

- ▶ safe start up and shutdown of the unit;
- ▶ setting and maintaining the desired temperature of the supply air with the control panel;
- ▶ motor speed control and regulation of the unit air capacity accordingly by means of the control panel;
- ▶ control of the external intake and exhaust air damper actuators;

Designation key:

Series	Rated air capacity, m ³ /h	Heater type	Duct connection	Row number of the heater
VENTS VUT	350; 500; 530; 600; 1000; 2000;	E – electric heater; W – water heater	H – horizontal duct connection	2 – two rows; 4 – four rows

Offered options to the units

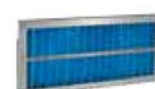

- ▶ working out the required patterns while the unit start up and shutdown;
- ▶ programming daily and weekly schedules by user;
- ▶ active electric heater overheating protection;
- ▶ disabling electric heater operation when the motor is not running;
- ▶ two electric heater over heating thermostats;
- ▶ automatic switch ensuring the short circuit protection of the automation system;
- ▶ controlling filter clogging.

VUT WH control and protection functions

- ▶ safe start up and shutdown of the unit;
- ▶ supply air temperature controlling by means of actuating three way valve regulating the feed of the heat medium into the water coils;

- ▶ water (glycol) heating coils freezing protection as the leaving air temperature and leaving heat medium temperature sensors require;
- ▶ controlling the heat exchanger by pass actuator;
- ▶ control of the external circulation pump operation installed on the heat medium entering into the water coils;
- ▶ heat exchanger icing protection;
- ▶ control of the intake and exhaust fan operation;
- ▶ air clogging control according to engine hours;
- ▶ control of the external intake and exhaust air damper actuators.

Air handling unit is equipped with the remote control panel that provides:

- ▶ starting up/shutdown of the ventilation unit;

- ▶ setting the required air flow;
- ▶ setting the required supply air temperature;
- ▶ displaying the temperature in the room.

Mounting

The air handling unit is mounted on the floor, suspended to the ceiling by means of a seat angle with inserted vibration damping element or attached to a wall with brackets. The unit can be mounted either in service spaces or in main premises above the suspended ceiling, in the pocket or can be placed directly in the room. Mounting in any position shall provide the correct condensate drainage. Access for the unit maintenance and filter cleaning shall be provided through the side panels.

Unit overall dimensions:

Type	Dimensions, [mm]											
	∅D	B	B1	B2	B3	H	H1	H2	H3	L	L1	L2
VUT 350 EH	124	497	403	248	348	554		111	230	954	996	1054
VUT 500 EH	149	497	403	248	348	554		111	230	954	996	1054
VUT 530 EH	159	497	403	248	348	554		111	230	954	996	1054
VUT 600 EH	199	497	403	248	348	554		111	230	954	996	1054
VUT 1000 EH	249	613	460	306	386	698	832	154	280	1071	1117	1171
VUT 1000 WH	249	613	460	306	386	698	832	154	280	1071	1117	1171
VUT 2000 EH	314	842	581	320	520	814	947	201	595	1345	1388	1445
VUT 2000 WH	314	842	581	320	520	814	947	201	595	1345	1388	1445

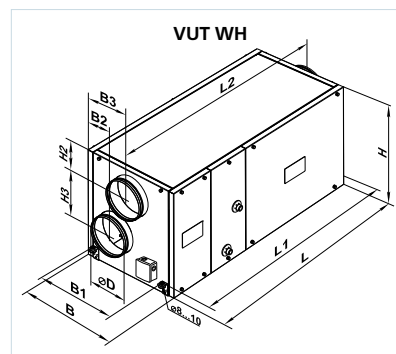
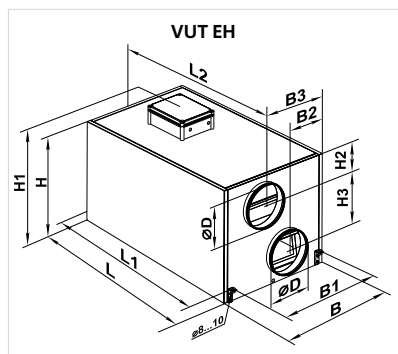

Accessories for air handling units:

Type	Replaceable filter (panel filter) G4	Replaceable filter (panel filter) F7
VUT 350 EH		
VUT 500 EH		
VUT 530 EH	SF VUT 300 600 EH/WH G4	SF VUT 300 600 EH/WH F7
VUT 600 EH		
VUT 1000 EH	SF VUT 1000 EH/WH G4	SF VUT 1000 EH/WH F7
VUT 2000 EH	SF VUT 2000 EH/WH G4	SF VUT 2000 EH/WH F7
VUT 1000 WH 2		
VUT 1000 WH 4	SF VUT 1000 EH/WH G4	SF VUT 1000 EH/WH F7
VUT 2000 WH 2		
VUT 2000 WH 4	SF VUT 2000 EH/WH G4	SF VUT 2000 EH/WH F7

AIR HANDLING UNITS WITH HEAT RECOVERY

Technical data:

	VUT 350 EH	VUT 500 EH	VUT 530 EH	VUT 600 EH
Unit supply voltage [V / 50 Hz]	1~230	1~230	1~230	1~230
Maximum fan power [W]	2pcs. x 130	2pcs. x 150	2pcs. x 150	2pcs. x 195
Fan current [A]	2pcs. x 0,60	2pcs. x 0,66	2pcs. x 0,66	2pcs. x 0,86
Electric heater capacity [kW]	3	3	4	4
Electric heater current [A]	13	13	17,4	17,4
Total power of the unit [kW]	3,26	3,3	4,3	4,39
Total current of the unit [A]	14,2	14,32	18,72	19,1
Air capacity [m ³ /h]	350	500	530	600
RPM	1150	1100	1100	1350
Noise level at 3m [dB(A)]	24 45	28 47	28 47	32 48
Operating temperature [°C]	25 up to +55	25 up to +50	25 up to +50	25 up to +55
Casing material	aluzink	aluzink	aluzink	aluzink
Insulation	25 mm mineral wool	25 mm mineral wool	25 mm mineral wool	25 mm mineral wool
Filter: exhaust	G4	G4	G4	G4
intake	F7 (EU7)	F7 (EU7)	F7 (EU7)	F7 (EU7)
Duct connection diameter, [mm]	∅ 125	∅ 150	∅ 160	∅ 200
Weight, [kg]	45	49	49	54
Recuperation efficiency	up to 78%	up to 88%	up to 88%	up to 85%
Heat exchanger type	cross flow type	cross flow type	cross flow type	cross flow type
Heat exchanger material	aluminum	aluminum	aluminum	aluminum

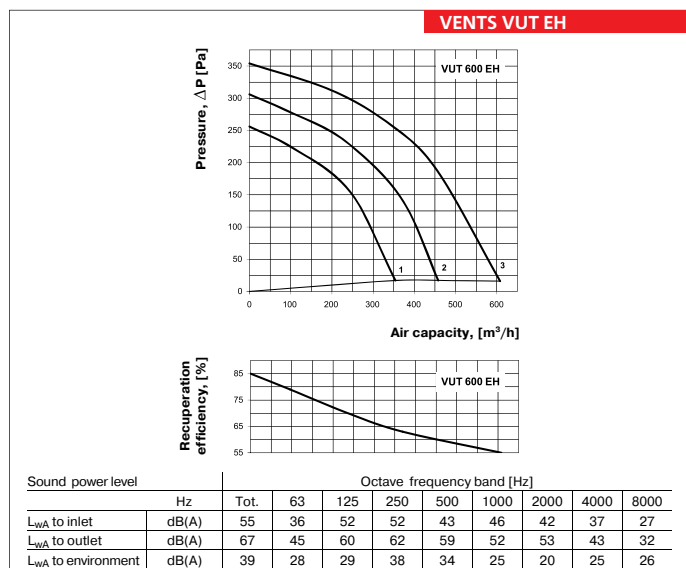
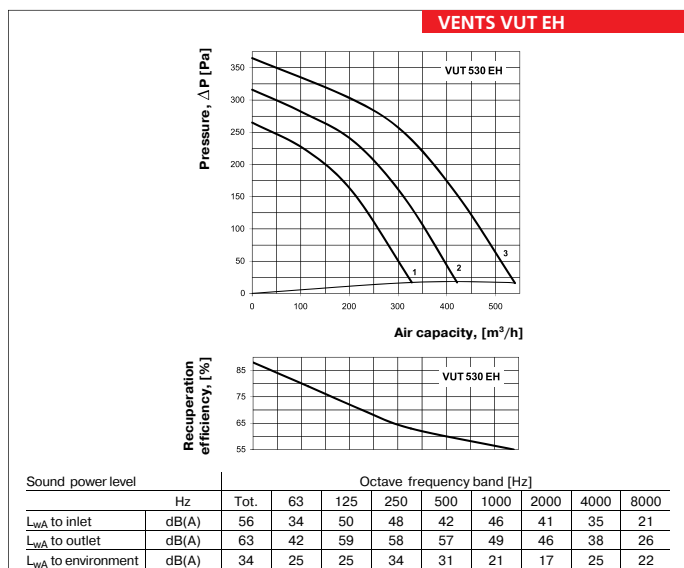
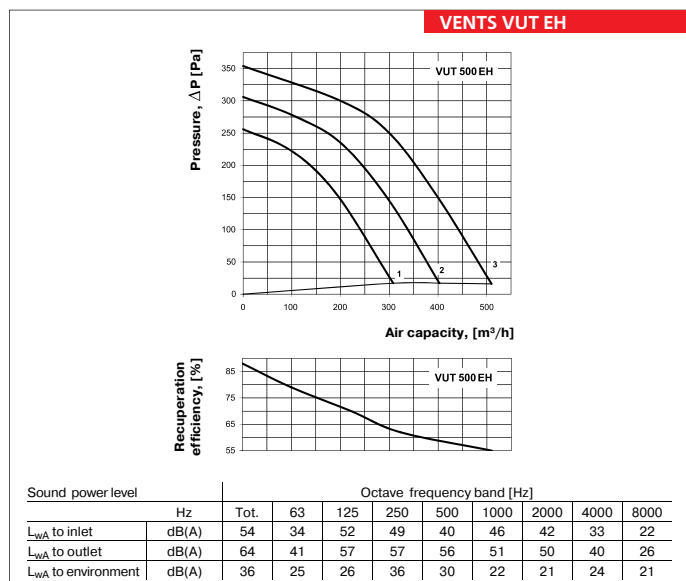
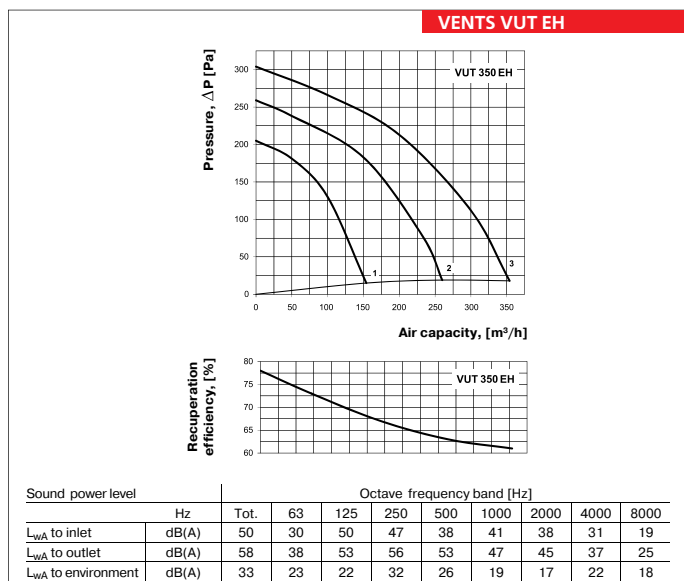

Technical data:

	VUT 1000 EH	VUT 1000 WH 2 VUT 1000 WH 4	VUT 2000 EH	VUT 2000 WH 2 VUT 2000 WH 4
Unit supply voltage [V / 50 Hz]	3~400	1~230	3~400	1~230
Maximum fan power [W]		2pcs. x 410		2pcs. x 650
Fan current [A]		2pcs. x 1,8		2pcs. x 2,84
Electric heater capacity [kW]	9,0		18,0	
Electric heater current [A]	13,0		26,0	
Number of water (glycol) coil rows		2 or 4		2 or 4
Total power of the unit [kW]	9,80	0,82	19,30	1,30
Total current of the unit [A]	16,6	3,6	31,7	5,68
Air capacity [m ³ /h]	1200	1100	2200	2100
RPM		1850		1150
Noise level at 3m [dB(A)]		60		65
Operating temperature [°C]		25 up to +40		25 up to +40
Casing material		aluzink		aluzink
Insulation		50 mm mineral wool		50 mm mineral wool
Filter: exhaust		G4		G4
intake		G4 (F7)*		G4 (F7)*
Duct connection diameter, [mm]		∅250		∅315
Weight, [kg]	85	88	96	99
Recuperation efficiency		up to 78%		up to 77%
Heat exchanger type		cross flow type		cross flow type
Heat exchanger material		aluminum		aluminum

*option

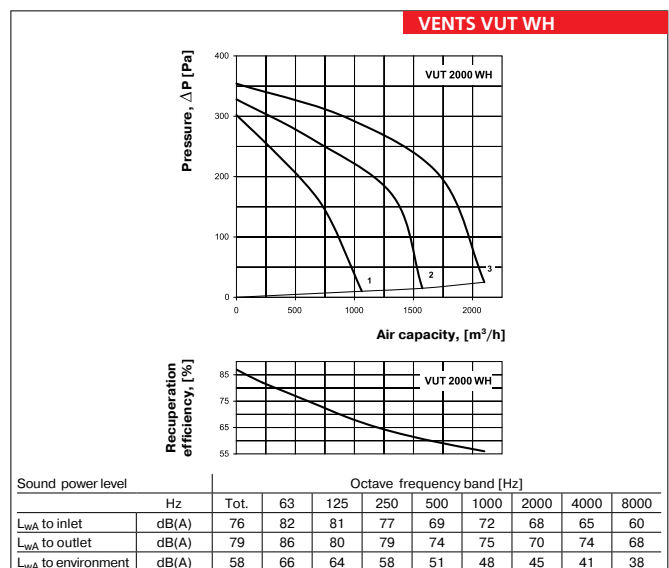
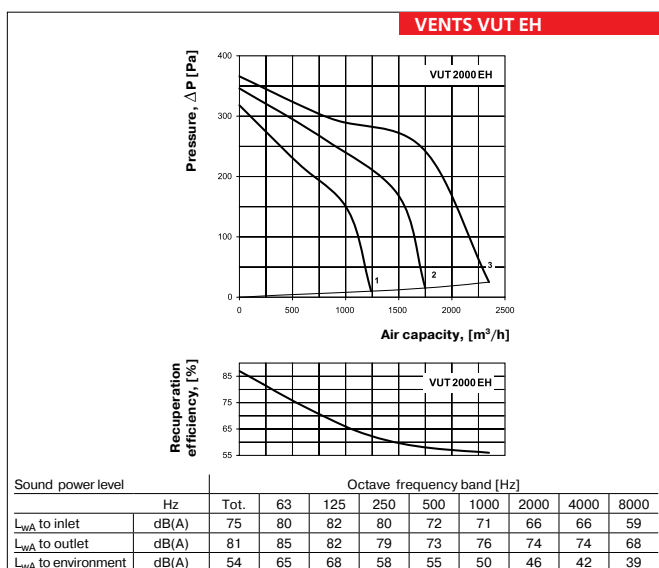
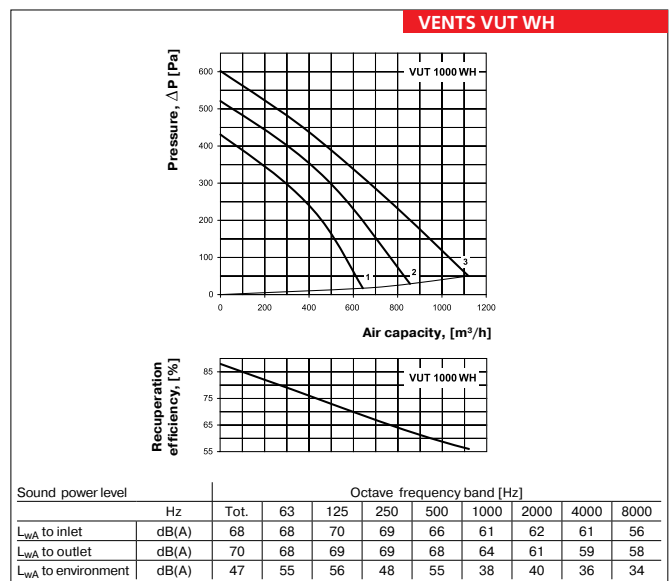
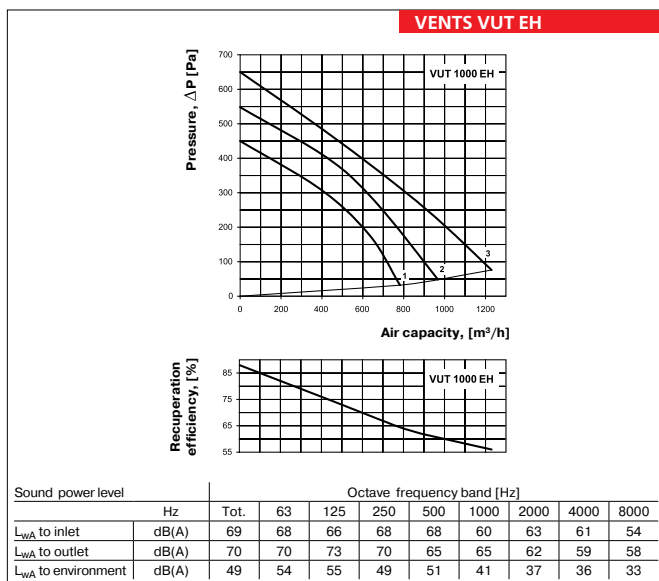

Hot water coil parameters:

VENTS VUT WH

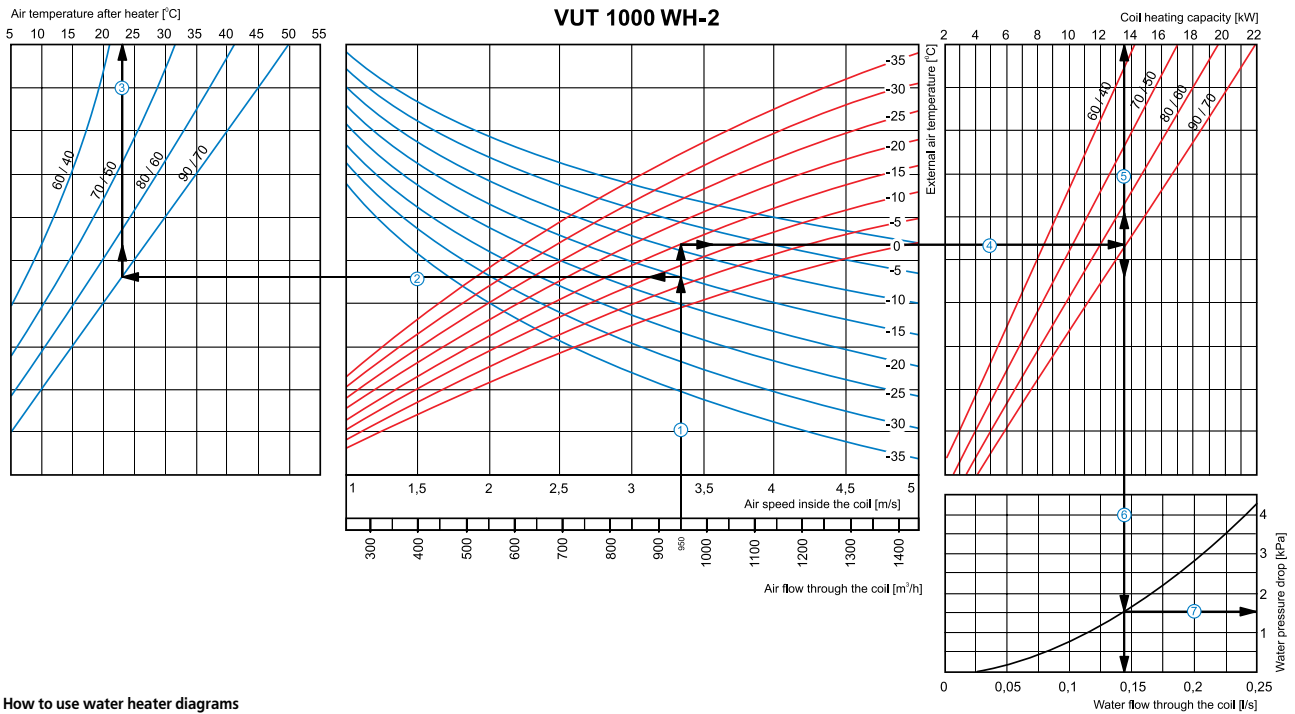

How to use water heater diagrams

System Parameters: Air flow = 950 m³/h. Outside air temper. = 15°C. Water temperature (in/out) = 90/70 °C

- Air Speed. Starting from 950 m³/h on the air flow scale draw a vertical line ① till the air speed axis which makes about 3.35 m/s.
- Supply air temperature. Prolong the line ① up to the point where it crosses the outside air temperature (blue curve, e.g. 15°C); then draw a horizontal line ② from this point to the left till crossing water in/out temperature curve (e.g. 90/70 °C). From this point draw a vertical line ③ to the supply air temperature axis on top of the graphic (+23°C).
- Heating coil capacity. Prolong the line ① up to the point where it crosses the outside air temperature (e.g. 15°C, red curve) and draw a horizontal line ④ from this point to the right until it crosses water in/out temperature curve (e.g., 90/70 °C), from here draw a vertical line ⑤ up to the scale representing the heating coil capacity (13.5 kW).
- Water discharge. Prolong the line ⑤ down to water discharge axis at the bottom of the graphic ⑥ (0.14 l/s).
- Water pressure drop. Draw the line ⑦ from the point where the line ⑥ crosses the black curve to the pressure drop axis. (1.5 kPa).

VENTS VUT WH

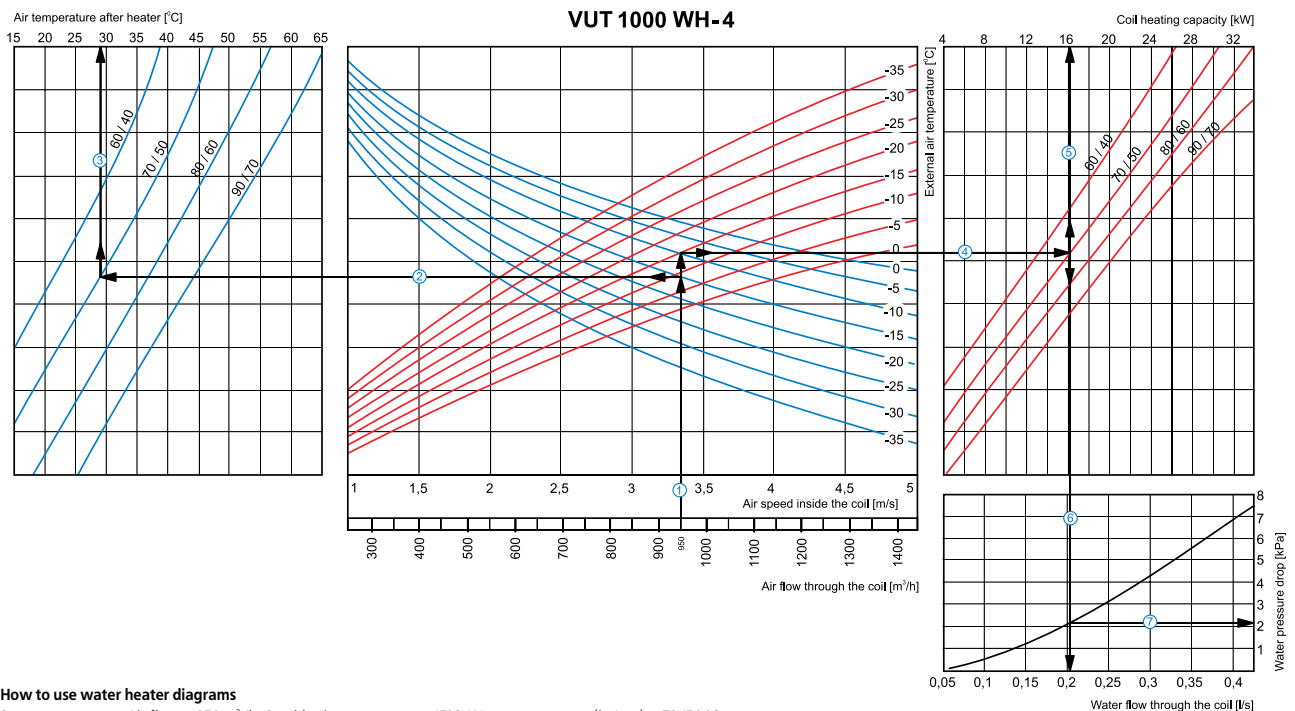

How to use water heater diagrams

System parameters: Air flow = 950 m³/h. Outside air temperature = 15°C. Water temperature (in/out) = 70/50 °C.

- Air Speed. Starting from 950 m³/h on the air flow scale draw a vertical line ① till the air speed axis which makes about 3.35 m/s.
- Supply air temperature. Prolong the line ① up to the point where it crosses the outside air temperature (blue curve, e.g. 15°C); then draw a horizontal line ② from this point to the left till crossing water in/out temperature curve (e.g. 70/50 °C). From this point draw a vertical line ③ to the supply air temperature axis on top of the graphic (+29°C).
- Heating coil capacity. Prolong the line ① up to the point where it crosses the outside air temperature (e.g. 15°C, red curve) and draw a horizontal line ④ from this point to the right until it crosses water in/out temperature curve (e.g., 70/50 °C), from here draw a vertical line ⑤ up to the scale representing the heating coil capacity (16.0 kW).
- Water discharge. Prolong the line ⑤ down to water discharge axis at the bottom of the graphic ⑥ (0.2 l/s).
- Water pressure drop. Draw the line ⑦ from the point where the line ⑥ crosses the black curve to the pressure drop axis. (2.1 kPa).

Hot water coil parameters:

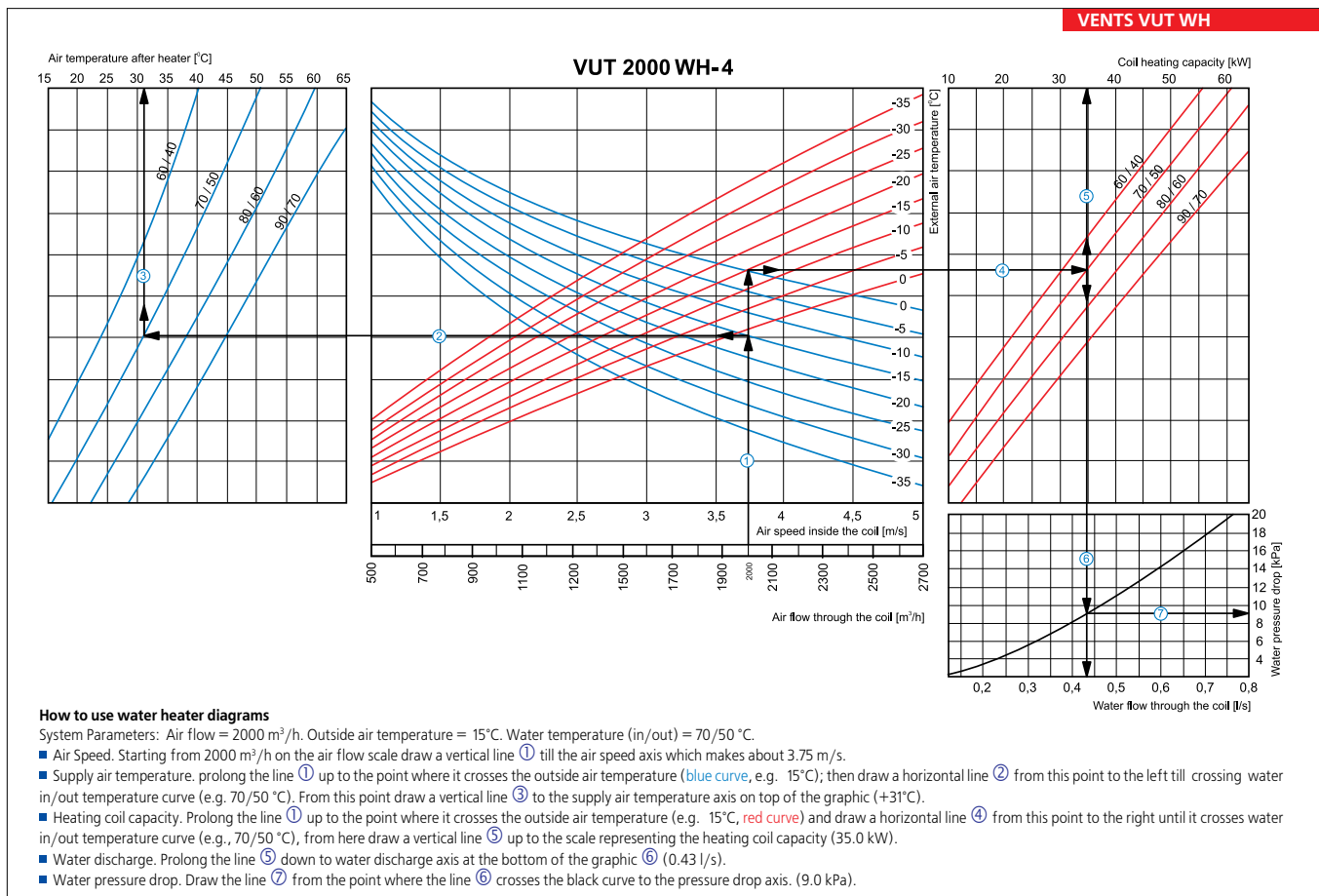
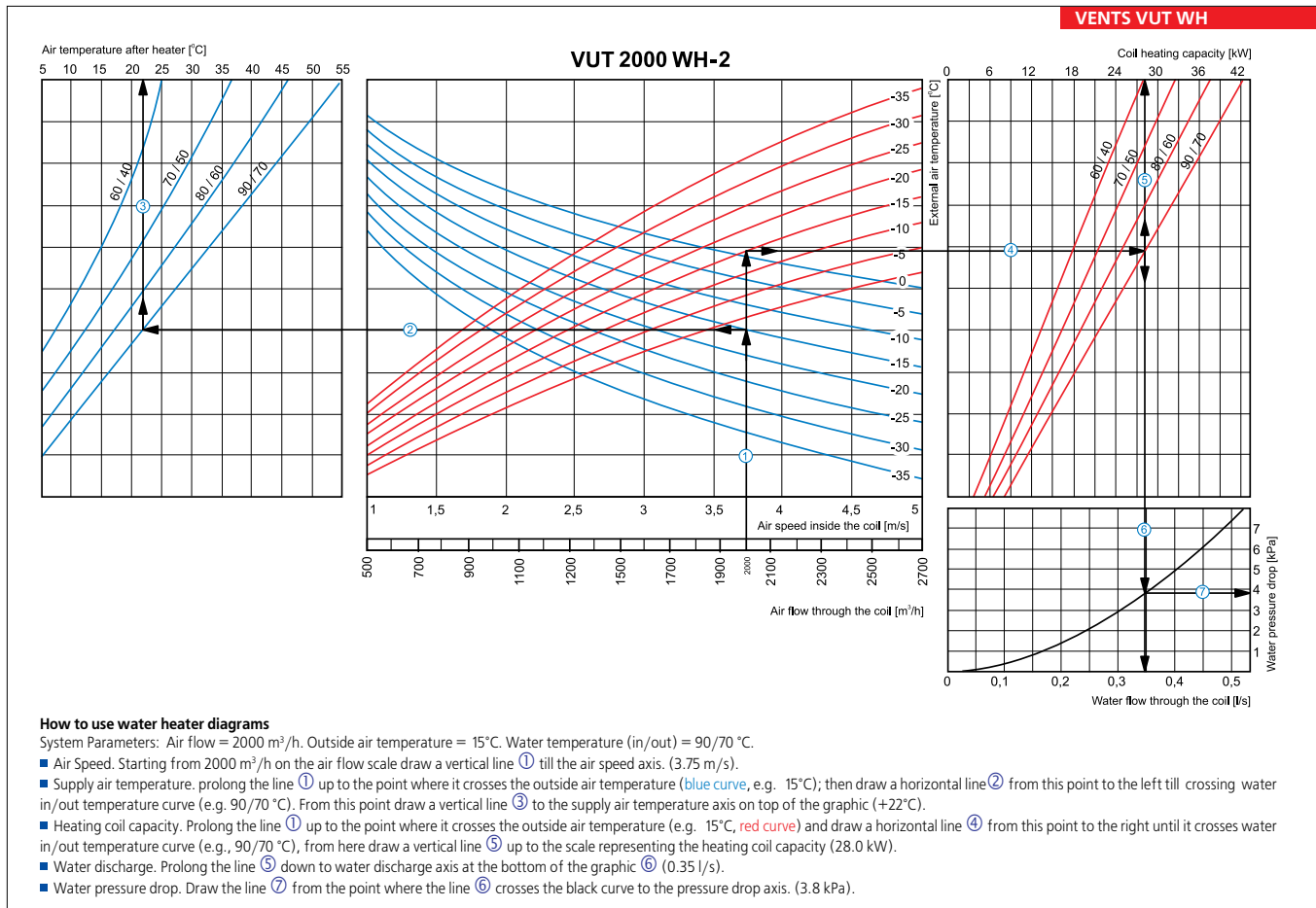

Series
VENTS VUT EH EC



LCD control panel



Air handling units with the air capacity up to **600 m³/h** and recuperation efficiency up to 95% in the sound and heat insulated casing.

Series
VENTS VUT WH EC



SAS908 control panel

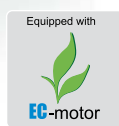

Air handling units with the air capacity up to **550 m³/h** and the recuperation efficiency up to 95% in the sound and heat insulated casing with the water heating coils.

■ **Description**

VUT EH EC air handling units with the electric heating battery and VUT WH EC with water heating coils are the complete ventilation units designed to provide both supply and exhaust ventilation, air filtration and cleaning as well as removal of contaminated exhaust air. The exhaust air energy is transferred to supply air through the plate heat exchanger. Applied in ventilation and conditioning systems for various premises requiring economic solution and controllable air exchange. EC motors reduce energy consumption by 1.5-3 times and ensure high efficiency and low noise level at the same time. All the models are compatible with Ø 150, 160 and 200 mm round ducts.

■ **Modifications**

VUT EH EC – a range of compact Energy saving Air Handling Units (AHU) equipped with intake and exhaust centrifugal fans with EC motors, counter

flow heat recovery elements, electric heater and air filters.

VUT WH EC – a range of compact Energy saving Air Handling Units (AHU) equipped with supply and exhaust centrifugal fans with EC motors, counter flow heat recovery elements, water or glycol heating coils and air filters.

■ **Casing**

The casing is manufactured from aluminum zinc compound with internal 25 mm mineral wool heat and sound insulating layer.

■ **Filter**

Two incorporated G4 panel filters for exhaust air ventilation and F7 filters for supply air ventilation are supplied with the unit.

■ **Fans**

The impellers with backward curved blades are powered by high efficient electronically commutated (EC) direct current motors with external rotor. As of today, such motor type is the most advanced solution for energy saving. EC motors are featured with high efficiency and the optimal control over the whole fan speed range. Premium efficiency (reaching 90%) is an absolute advantage of the electronically commutated motors.

■ **Heat recovery**

The units are equipped with the high efficient heat exchangers reaching up to 95%. VUT EH EC and VUT WH EC models are fitted with the counter flow heat exchangers made of polystyrene. The unit is equipped with the drain pan at the bottom of the heat exchanger for condensate drainage.

Designation key:

Series	Rated air capacity, m ³ /h	Heater type	Duct connection	Motor type
VENTS VUT	300; 400; 600	E – electric heater; W – water heater	H – horizontal duct connection	EC – electronically commutated synchronous motor

Offered options to the units

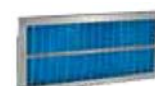

■ Heater

If the outside temperature is too low and/or heat energy transfer from the extract air is insufficient to heat up the incoming air to the required temperature, the heater automatically be turned on. The control system regulates the heating power to keep the indoor temperature as set by the user. The units supplied with the water heaters are marked as VUT WH, and the units with electric heaters are marked as VUT EH.

■ Control and automation

The unit is equipped with the built in automation system with multifunctional control panel with graphic LED display.

The standard delivery set includes 10 m wire for connection to the control panel. Electronic icing protection prevents the heat exchanger freezing. It includes the by pass damper and heater. The temperature sensor activates the by pass air shutter opening to let the air flow pass through the heat exchanger by pass duct. During the heat exchanger defrost cycle the supply air is warmed up in the heater up to the required temperature. During the defrosting process the warm exhaust air warms the heat exchanger. After that the by pass damper closes again, the heater is switched off, supply air warms up again through the heat exchanger and the unit continues operating under rated conditions.

■ VUT EH EC control and protection functions

- ▶ safe start up and shutdown of the unit;
- ▶ setting and maintaining the desired temperature of supply air with the control panel;
- ▶ motor speed control and air capacity regulation accordingly by means of the control panel;
- ▶ control of the external intake and exhaust air damper actuators;
- ▶ working out the required patterns while the unit start up and shutdown;
- ▶ programming daily and weekly schedules by user;
- ▶ active electric heating elements overheating protection;
- ▶ disabling electric heater operation when the motor is not running;
- ▶ two electric heater over heating thermostats;
- ▶ automatic switch ensuring the short circuit protection of the automation system;
- ▶ control of filter clogging.

■ VUT WH (EC) control and protection functions

- ▶ safe start up and shutdown of the unit;
- ▶ supply air temperature control by means of actuating three way valve regulating the feed of the heat medium into the water coils;
- ▶ water (glycol) heating coils freezing protection as the leaving air temperature and leaving heat medium temperature sensors require;
- ▶ controlling the heat exchanger by pass actuator;

- ▶ control of the external circulation pump installed on the heat medium entering into the water coils;
- ▶ heat exchanger icing protection;
- ▶ control of the supply and exhaust fans;
- ▶ air clogging controlling (according to engine hours);
- ▶ control of the external intake and exhaust air damper actuators.

The air handling unit is equipped with the remote control panel that provides:

- ▶ starting up/shutdown of the ventilation unit;
- ▶ setting the required air capacity;
- ▶ setting the required supply air temperature;
- ▶ displaying the temperature in the room.

■ Mounting

Air handling unit is mounted on the floor, suspended to the ceiling by means of a seat angle with inserted vibration damping element or attached to a wall with brackets. The unit can be mounted either in service spaces or in main premises above the suspended ceiling, in the pocket or the unit can be placed directly in the room. Mounting in any position shall provide the correct condensate drainage. Access for the unit maintenance and filter cleaning shall be reserved on the pane side.

Accessories for air handling units:

Type	G4 replaceable filter (panel filter)	F7 replaceable filter (panel filter)
VUT 300 1 EH EC VUT 300 2 EH EC VUT 400 EH EC VUT 600 EH EC VUT 300 1 WH EC VUT 300 2 WH EC VUT 400 WH EC VUT 600 WH EC	SF VUT 300 600 EH/WH G4	SF VUT 300 600 EH/WH F7

AIR HANDLING UNITS WITH HEAT RECOVERY

Unit overall dimensions:

Type	Dimensions, [mm]										
	∅D	B	B1	B2	B3	H	H2	H3	L	L1	L2
VUT 300 1 EH EC	149	500	403	161	249	555	127	231	1092	1137	1198
VUT 300 2 EH EC	159	500	403	161	249	555	127	231	1092	1137	1198
VUT 400 EH EC	199	500	403	161	249	555	127	231	1092	1137	1198
VUT 600 EH EC	199	500	403	161	249	555	127	231	1092	1137	1198
VUT 300 1 WH EC	149	500	403	161	249	555	127	231	1092	1137	1198
VUT 300 2 WH EC	159	500	403	161	249	555	127	231	1092	1137	1198
VUT 400 WH EC	199	500	403	161	249	555	127	231	1092	1137	1198
VUT 600 WH EC	199	500	403	161	249	555	127	231	1092	1137	1198

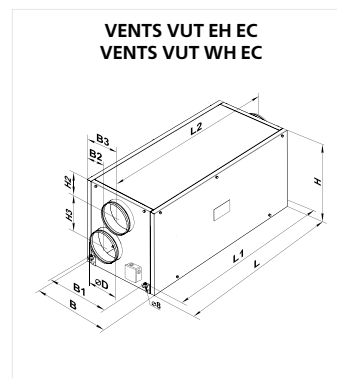

Technical data:

	VUT 300 1 EH EC	VUT 300 2 EH EC	VUT 300 1 WH EC	VUT 300 2 WH EC
Unit supply voltage [V / 50 Hz]			1~ 230	
Maximum fan power [W]			2pcs. x 70	
Fan current [A]			2pcs. x 0,60	
Electric heater capacity [kW]	3,0			
Electric heater current [A]	13,0			
Number of water (glycol) coil rows			2	
Total power of the unit [kW]	3,14			0,14
Total current of the unit [A]	14,2			1,2
Air capacity [m³/h]			300	
RPM			1380	
Noise level at 3m [dB[A]]	24 45			24 45
Operating temperature [°C]			25 up to +60	
Casing material			aluzink	
Insulation			25 mm mineral wool	
Filter: exhaust			G4	
intake			F7 (EU7)	
Duct connection diameter, [mm]	∅ 150	∅ 160	∅ 150	∅ 160
Weight, [kg]	38			40
Recuperation efficiency			up to 90%	
Heat exchanger type			counter flow	
Heat exchanger material			polystyrene	

Technical data:

	VUT 400 EH EC	VUT 400 WH EC	VUT 600 EH EC	VUT 600 WH EC
Unit supply voltage [V / 50 Hz]			1~ 230	
Maximum fan power [W]			2pcs. x 175	
Fan current [A]			2pcs. x 1,3	
Electric heater capacity [kW]	4,0		4,0	
Electric heater current [A]	17,4		17,4	
Number of water (glycol) coil rows		2		2
Total power of the unit [kW]	4,35	0,35	4,35	0,35
Total current of the unit [A]	20,0	2,6	20,0	2,6
Air capacity [m³/h]	400		600	550
RPM	1340		2150	
Noise level at 3m [dB[A]]	28 47	28 47	28 47	28 47
Operating temperature [°C]	25 up to +60		25 up to +60	
Casing material	aluzink		aluzink	
Insulation	25 mm mineral wool		25 mm mineral wool	
Filter: exhaust	G4		G4	
intake	F7 (EU7)		F7 (EU7)	
Duct connection diameter, [mm]	∅ 200		∅ 200	
Weight, [kg]	38	40	38	40
Recuperation efficiency	up to 90%		up to 90%	
Heat exchanger type	counter flow		counter flow	
Heat exchanger material	polystyrene		polystyrene	

VENTS VUT EH EC

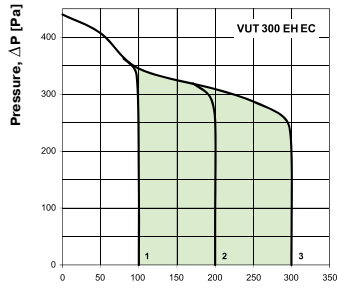

Air capacity, [m³/h]

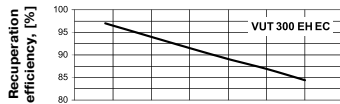

Sound power level		Octave frequency band [Hz]								
	Hz	Tot.	63	125	250	500	1000	2000	4000	8000
L _{WA} to inlet	dB(A)	51	30	48	46	37	42	36	32	21
L _{WA} to outlet	dB(A)	60	41	54	57	55	44	46	35	24
L _{WA} to environment	dB(A)	33	23	23	32	27	19	15	19	18

VENTS VUT WH EC

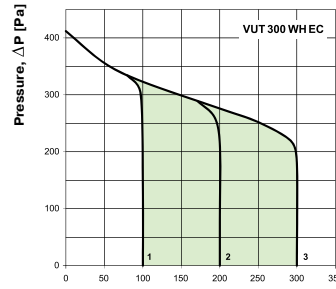

Air capacity, [m³/h]

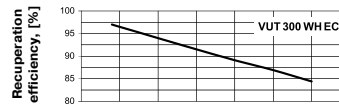

Sound power level		Octave frequency band [Hz]								
	Hz	Tot.	63	125	250	500	1000	2000	4000	8000
L _{WA} to inlet	dB(A)	49	30	46	49	39	42	38	31	20
L _{WA} to outlet	dB(A)	60	39	55	58	52	45	45	35	26
L _{WA} to environment	dB(A)	34	20	23	30	27	18	18	20	21

VENTS VUT EH EC

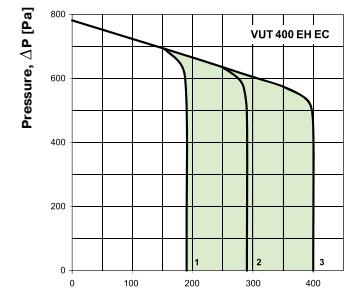

Air capacity, [m³/h]

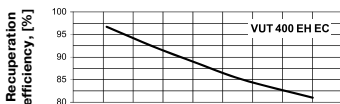

Sound power level		Octave frequency band [Hz]								
	Hz	Tot.	63	125	250	500	1000	2000	4000	8000
L _{WA} to inlet	dB(A)	54	32	50	51	40	43	40	37	25
L _{WA} to outlet	dB(A)	65	44	57	58	54	51	48	38	27
L _{WA} to environment	dB(A)	37	27	28	32	29	22	19	21	23

VENTS VUT WH EC

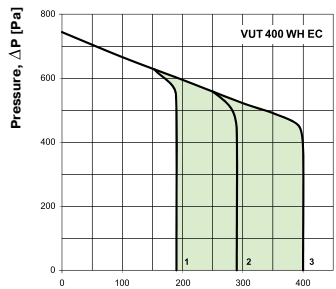

Air capacity, [m³/h]

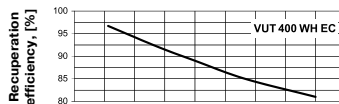

Sound power level		Octave frequency band [Hz]								
	Hz	Tot.	63	125	250	500	1000	2000	4000	8000
L _{WA} to inlet	dB(A)	56	33	51	50	40	44	41	37	22
L _{WA} to outlet	dB(A)	62	42	57	58	58	48	49	36	26
L _{WA} to environment	dB(A)	36	25	27	34	29	20	19	25	23

VENTS VUT EH EC

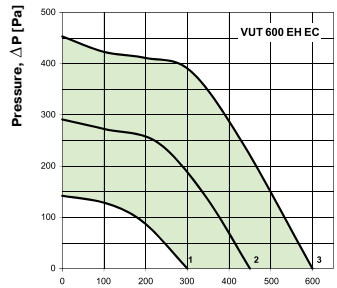

Air capacity, [m³/h]

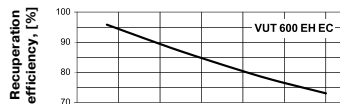

Sound power level		Octave frequency band [Hz]								
	Hz	Tot.	63	125	250	500	1000	2000	4000	8000
L _{WA} to inlet	dB(A)	59	36	55	54	43	46	43	38	26
L _{WA} to outlet	dB(A)	68	45	60	64	61	52	52	40	29
L _{WA} to environment	dB(A)	38	29	31	38	31	26	24	27	26

VENTS VUT WH EC

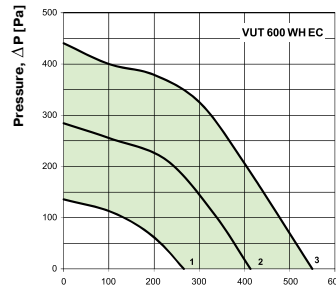

Air capacity, [m³/h]

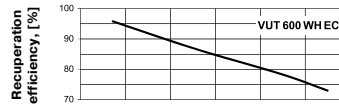

Sound power level		Octave frequency band [Hz]								
	Hz	Tot.	63	125	250	500	1000	2000	4000	8000
L _{WA} to inlet	dB(A)	59	38	56	52	41	47	44	40	24
L _{WA} to outlet	dB(A)	66	45	59	62	57	52	50	39	30
L _{WA} to environment	dB(A)	41	26	31	35	32	25	24	24	28

Hot water coil parameters:

VENTS VUT WH EC

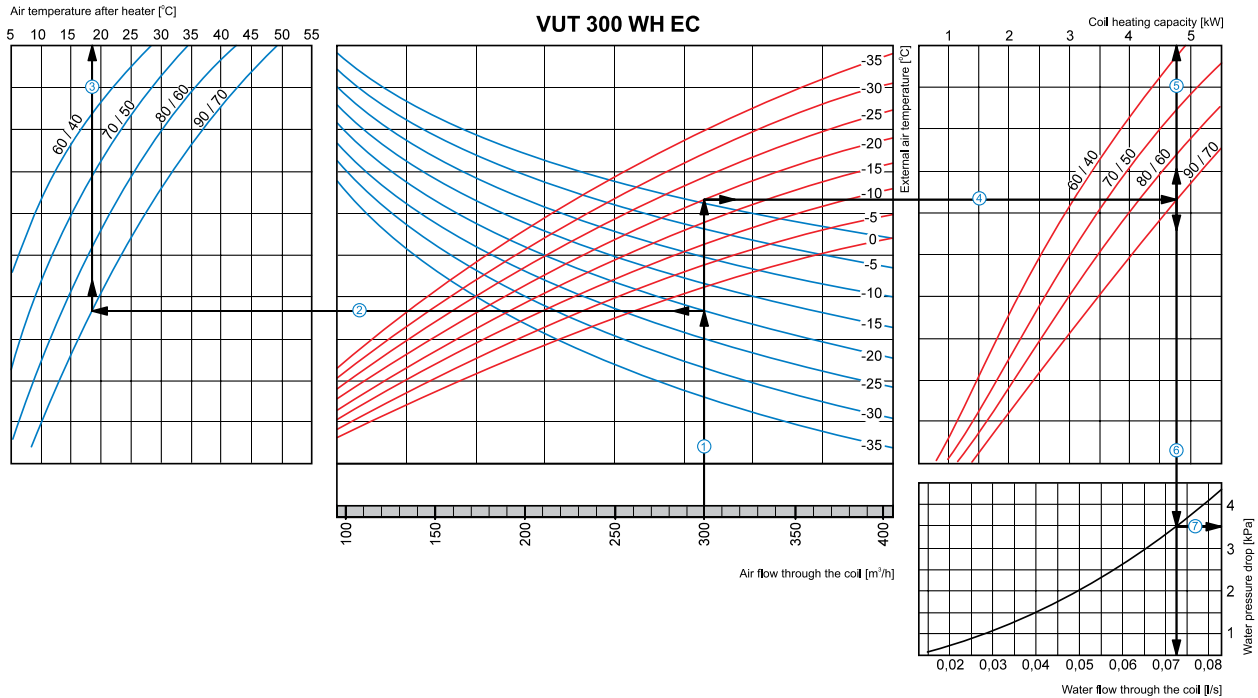

How to use water heater diagrams

System Parameters: Air flow = 300 m³/h. Outside air temperature = 20°C. Water temperature (in/out) = 90/70 °C.

- Supply air temperature. prolong the line of air flow (e.g., 300 m³/h) ① up to the point where it crosses the outside air temperature (blue curve, e.g. 20°C); then draw a horizontal line ② from this point to the left till crossing water in/out temperature curve (e.g. 90/70 °C). From this point draw a vertical line ③ to the supply air temperature axis on top of the graphic (+18°C).
- Heating coil capacity. Prolong the line ① up to the point where it crosses the outside air temperature (e.g. 20°C, red curve) and draw a horizontal line ④ from this point to the right until it crosses water in/out temperature curve (e.g., 90/70 °C), from here draw a vertical line ⑤ up to the scale representing the heating coil capacity (4.75 kW).
- Water discharge. Prolong the line ⑤ down to water discharge axis at the bottom of the graphic ⑥ (0.072 l/s).
- Water pressure drop. Draw the line ⑦ from the point where the line ⑥ crosses the black curve to the pressure drop axis. (3.5 kPa).

VENTS VUT WH EC

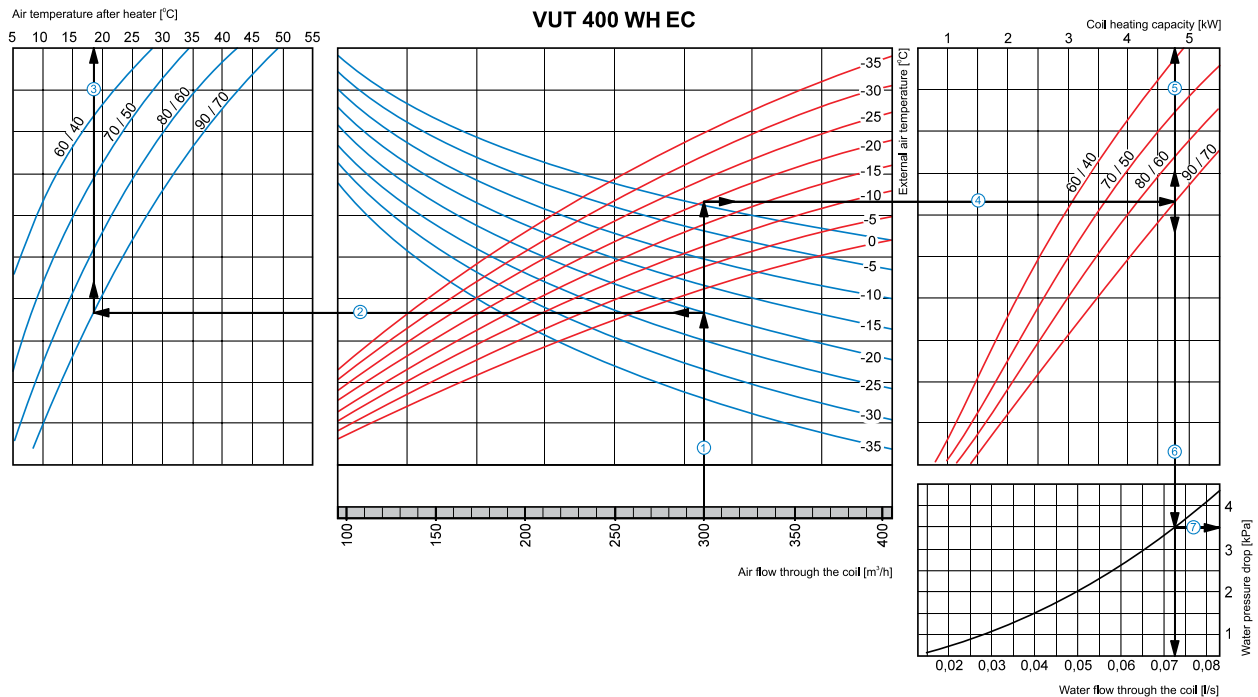

How to use water heater diagrams

System Parameters: Air flow = 300 m³/h. Outside air temperature = 20°C. Water temperature (in/out) = 90/70 °C.

- Supply air temperature. prolong the line of air flow (e.g., 300 m³/h) ① up to the point where it crosses the outside air temperature (blue curve, e.g. 20°C); then draw a horizontal line ② from this point to the left till crossing water in/out temperature curve (e.g. 90/70 °C). From this point draw a vertical line ③ to the supply air temperature axis on top of the graphic (+18°C).
- Heating coil capacity. Prolong the line ① up to the point where it crosses the outside air temperature (e.g. 20°C, red curve) and draw a horizontal line ④ from this point to the right until it crosses water in/out temperature curve (e.g., 90/70 °C), from here draw a vertical line ⑤ up to the scale representing the heating coil capacity (4.75 kW).
- Water discharge. Prolong the line ⑤ down to water discharge axis at the bottom of the graphic ⑥ (0.072 l/s).
- Water pressure drop. Draw the line ⑦ from the point where the line ⑥ crosses the black curve to the pressure drop axis. (3.5 kPa).

Hot water coil parameters:

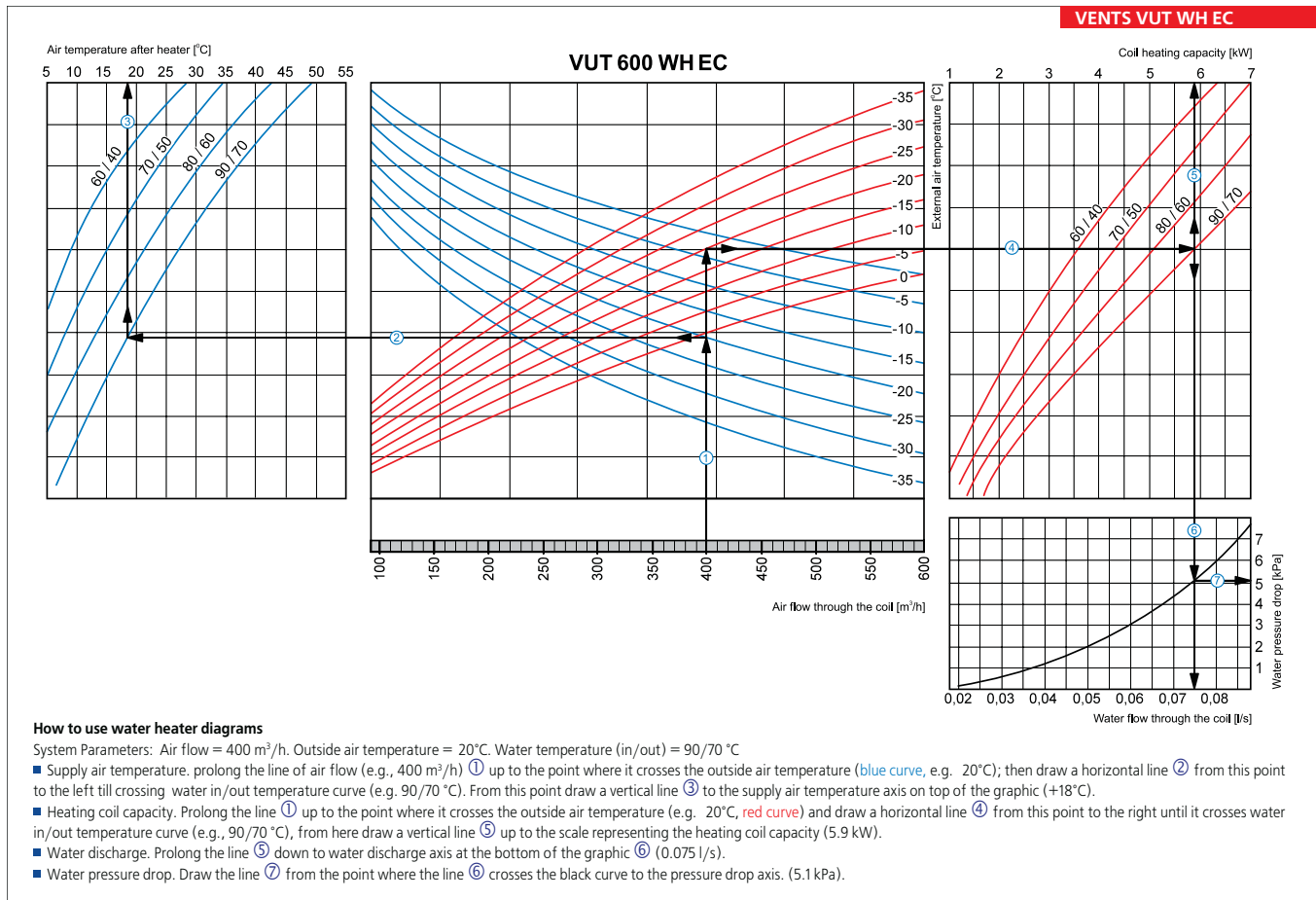

VUT EH EC ventilation and air exchange example in the cottage.

Series
VENTS VUT PE EC



Series
VENTS VUT PW EC



A range of compact ceiling mounted energy saving Air Handling Units (AHU) with the air capacity up to **4000 m³/h** and the heat exchanger efficiency up to 90% in the sound and heat insulated casing with the electric heater.

A range of compact ceiling mounted Energy saving Air Handling Units (AHU) with the air capacity up to **3800 m³/h** and the heat exchanger efficiency up to 90% in the sound and heat insulated casing with the water heater.

■ **Description**

Air handling unit VUT PE EC with the electric heater and VUT PW EC with the water heating coils are the complete ventilation units designed to provide both supply and exhaust ventilation with air filtration and contaminated exhaust air removal. The exhaust air energy is used to heat up the supply fresh air through the plate heat exchanger.

Designed for ventilation and conditioning systems for various premises requiring economic solution and controllable air exchange. EC motors reduce energy consumption by 1.5 3 times and ensure high efficiency and low noise level at the same time. All the models are compatible with 160 (150), 200, 250, 315 и 400 mm round ducts.

■ **Modifications**

VUT PE EC – models with the electric heater.
VUT PW EC – models with water heating coils.

■ **Casing**

The casing is made of aluzink with 20 mm mineral

wool internal heat and sound insulating layer for VUT PE/PW 350, 600, 1000 units and 50 mm for VUT PE/PW 200, 3000 units.

■ **Filter**

Two incorporated G4 panel filters for supply and exhaust air ventilation are supplied with the unit.

■ **Motor**

VUT PE/PW EC units are equipped with exhaust and supply fans with backward curved blades powered by energy saving direct current Electronically Commutated (EC) motors. These motors give up to 50% energy consumption economy as compared to standard AC motors. EC motors have built in thermal overheating protection with automatic restart and enable smooth speed regulation from 0 to 100%. The ball bearings used with the EC motors are designed for at least 40 000 hours operation and are maintenance free. Premium efficiency reaching 90% is an absolute privilege of the electronically commutated motor.

■ **Heat exchanger**

VUT 350, 600 and 1000 models are fitted with the counter flow heat recovery element made of polystyrene. VUT 2000 and 3000 models are manufactured with the cross flow air to air plate heat exchanger made of aluminum. All the units are equipped with the drain pan for condensate drainage.

■ **Heater**

The units are supplied with the water coils (VUT PW) or electric heater (VUT PE). If the external temperature is too low and/or heat energy transfer from the exhaust air is insufficient to heat up the supply air to the required temperature, the heater is turned automatically on. The control system regulates the heating power to keep the indoor temperature as set up by the user.

■ **Automation**

The unit is equipped with the built in automation system with multifunctional control panel and graphic LCD indicator. The standard delivery set includes 10 m

Designation key:

Series	Rated air capacity, m ³ /h	Model	Heater type	Motor type
VENTS VUT	350; 600; 1000; 2000; 3000	P – suspended	E – electric heater; W – water heater	EC – electronically commutated synchronous motor

Offered options to the units



page 65

page 65

wire for connection to the control panel. To prevent the heat exchanger freezing the icing electronic protection is applied. It includes the by pass damper and the heater. The by pass damper is opened as the temperature sensor requires and to let the air flow pass through the heat exchanger through the by pass duct. During the heat exchanger defrost cycle the supply air is warmed up in the heater up to the required temperature. During the defrosting process the warm exhaust air warms the heat exchanger. After that the by pass damper closes again, the heater is switched off, supply air warms up again through the heat exchanger and the unit continues operating under rated conditions.

VUT PE (EC) control and protection functions

- ▶ safe start up and shutdown of the unit;
- ▶ setting and maintaining the desired temperature of the supply air with the control panel;
- ▶ motor speed control and regulation of the unit air capacity accordingly by means of the control panel;
- ▶ control of the external intake and exhaust air damper actuators;
- ▶ working out the required patterns while the unit start up and shutdown;

- ▶ programming daily and weekly schedules by user;
- ▶ active electric heating elements overheating protection;
- ▶ disabling electric heater operation when the motor is not running;
- ▶ two electric heater overheating thermostats;
- ▶ automatic switch ensuring the short circuit protection of the automation system;
- ▶ controlling filter clogging.

General description of VUT PW (EC) control system

The unit is equipped with the built in automatic control and monitoring system.

The control unit performs the following functions:

- ▶ safe start up and shutdown of the unit;
- ▶ supply air temperature control by means of actuating three way valve regulating the feed of the heat medium into the water coils;
- ▶ water (glycol) heating coils freezing protection as the leaving air temperature and leaving heat medium temperature sensors require;
- ▶ control of the heat exchanger by pass actuator;
- ▶ control of the of external circulation pump installed on the heat medium entering into the

water coils;

- ▶ heat exchanger icing protection;
- ▶ control of the supply and exhaust fans;
- ▶ air clogging control according to engine hours;
- ▶ control of the external intake and exhaust air damper actuators.

Air handling unit is equipped with the remote control panel that provides:

- ▶ starting up/shutdown of the ventilation unit;
- ▶ setting the required air flow;
- ▶ setting the required supply air temperature;
- ▶ displaying the temperature in the room;
- ▶ failure (emergency) alarm indication.

Mounting

Air handling unit is suspended to the ceiling. The unit can be mounted either in service spaces or in main premises above the suspended ceiling, in the pocket or the unit can be placed directly in the room. Mounting in any position shall provide the correct condensate drainage. Access for the unit maintenance and filter cleaning shall be provided through the side panels.

Unit overall dimensions:

Type	Dimensions, [mm]											Figure №
	∅D	B	B1	B2	B3	B4	H	H1	L	L1	L2	
VUT 350 PE EC	160	485	415	596	132,5	220	285	130	1238	1286	948	1
VUT 600 PE EC	199	827	711		294	345	283	120	1238	1286		2
VUT 1000 PE EC	249	1350	1215	607,5	430	655	317	143	1346	1395		2
VUT 2000 PE EC	314	1050	915	457,5	247	575	750	375	1360	1408		2
VUT 3000 PE EC	399	1265	1130	565	297	632,5	830	415	1595	1643		2
VUT 600 PW EC	199	827	711		294	345	283	120	1238	1286		2
VUT 1000 PW EC	249	1350	1215	607,5	430	655	317	143	1346	1395		2
VUT 2000 PW EC	314	1050	915	457,5	247	575	750	375	1360	1408		2
VUT 3000 PW EC	399	1265	1130	565	297	632,5	830	415	1595	1643		2

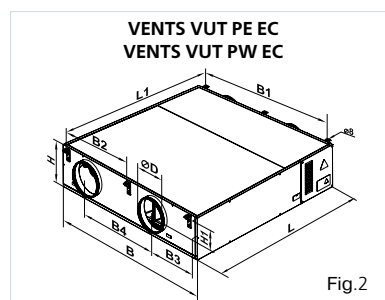
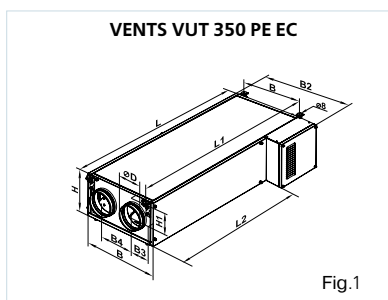

AIR HANDLING UNITS WITH HEAT RECOVERY

Technical data:

	VUT 350 PE EC	VUT 600 PE EC	VUT 600 PW EC
Unit supply voltage [V / 50 Hz]	1~ 230		1~ 230
Maximum fan power [W]	2pcs. x 51		2pcs. x 100
Fan current [A] (Supply voltage of the fan with EC motor)	2pcs. x 1,2 (48V)		2pcs. x 2,4 (48V)
Electric heater capacity [kW]	1,5	2,0	
Electric heater current [A]	6,5	8,7	
Total power of the unit [kW]	1,502	2,20	0,20
Total current of the unit [A]	7,05	9,76	1,06
Air capacity [m ³ /h]	400	700	600
RPM	2950		3150
Noise level at 3m [dB[A]]	48		53
Operating temperature [°C]	25 up to +40		25 up to +60
Casing material	aluzink		aluzink
Insulation	20 mm mineral wool		20 mm mineral wool
Filter: exhaust	G4		G4
intake	G4		G4
Duct connection diameter, [mm]	∅ 160 (150)*		∅ 200
Weight, [kg]	65	75	77
Recuperation efficiency	up to 90%		up to 90%
Heat exchanger type	counter flow		counter flow
Heat exchanger material	polystyrene		polystyrene

* in case of reducer ∅ 160/150 mm.

Technical data:

	VUT 1000 PE EC	VUT 1000 PW EC	VUT 2000 PE EC	VUT 2000 PW EC
Unit supply voltage [V / 50 Hz]	1~ 230		3~ 400	1~ 230
Maximum fan power [W]	2pcs. x 135		2pcs. x 420	
Fan current [A] (Supply voltage of the fan with EC motor)	2pcs. x 2,8 (48V)		2pcs. x 2,5 (230V)	
Electric heater capacity [kW]	3,3		12,0	
Electric heater current [A]	14,3		17,4	
Total power of the unit [kW]	3,57	0,27	12,84	0,84
Total current of the unit [A]	15,53	1,23	22,4	5
Air capacity [m ³ /h]	1100	1000	2000	1950
RPM	2645		2920	
Noise level at 3m [dB[A]]	52		58	
Operating temperature [°C]	25 up to +60		25 up to +40	
Casing material	aluzink		aluzink	
Insulation	20 mm mineral wool		50 mm mineral wool	
Filter: exhaust	G4		G4	
intake	G4		G4	
Duct connection diameter, [mm]	∅ 250		∅ 315	
Weight, [kg]	95	98	190	194
Recuperation efficiency	up to 90%		up to 75%	
Heat exchanger type	counter flow		cross flow	
Heat exchanger material	polystyrene		aluminum	

Technical data:

	VUT 3000 PE EC	VUT 3000 PW EC
Unit supply voltage [V / 50 Hz]	3~ 400	
Maximum fan power [W]	2pcs. x 990	
Fan current [A] (Supply voltage of the fan with EC motor)	2pcs. x 1,7 (400V)	
Electric heater capacity [kW]	18,0	
Electric heater current [A]	26,0	
Total power of the unit [kW]	19,98	1,98
Total current of the unit [A]	29,4	3,4
Air capacity [m³/h]	4000	3800
RPM	2580	
Noise level at 3m [dB[A]]	59	
Operating temperature [°C]	25 up to +50	
Casing material	aluzink	
Insulation	50 mm mineral wool	
Filter: exhaust	G4	
intake	G4	
Duct connection diameter, [mm]	ø400	
Weight, [kg]	290	295
Recuperation efficiency	up to 75%	
Heat exchanger type	cross flow	
Heat exchanger material	aluminum	

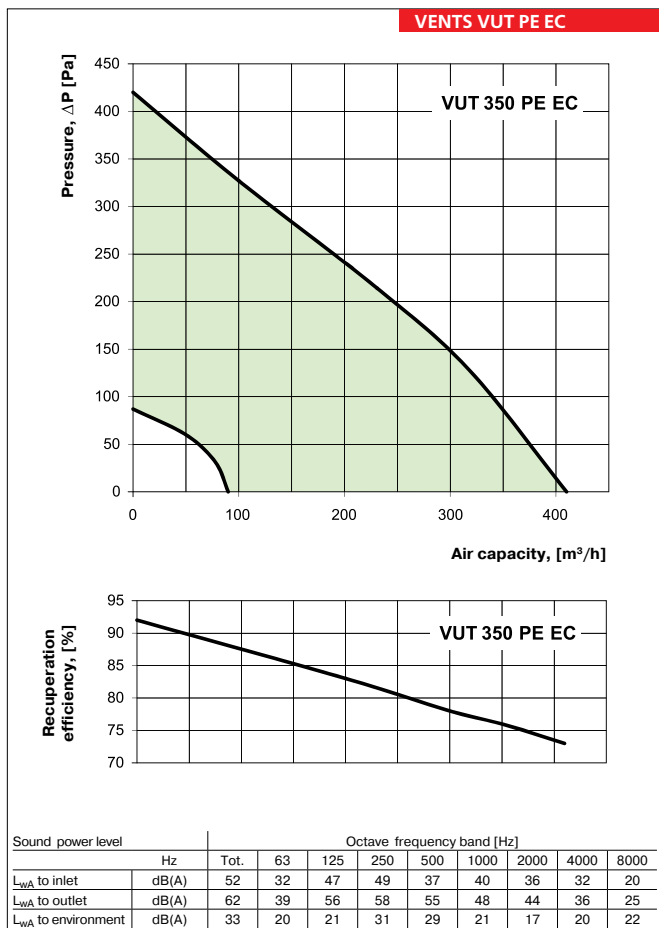

Accessories to air handling units:

Type	Replaceable filter	
	Intake (pocket type)	Exhaust (panel type)
VUT 350 PE EC	SFK 350 PE G4	SF 350 PE G4
VUT 600 PE EC	SFK 600 PE/PW G4	SF 600 PE/PW G4
VUT 1000 PE EC	SFK 1000 PE/PW G4	SF 1000 PE/PW G4
VUT 2000 PE EC	SF 2000 PE/PW G4	
VUT 3000 PE EC	SF 3000 PE/PW G4	
VUT 600 PW EC	SFK 600 PE/PW G4	SF 600 PE/PW G4
VUT 1000 PW EC	SFK 1000 PE/PW G4	SF 1000 PE/PW G4
VUT 2000 PW EC	SF 2000 PE/PW G4	
VUT 3000 PW EC	SF 3000 PE/PW G4	

AIR HANDLING UNITS WITH HEAT RECOVERY

VENTS VUT PE EC

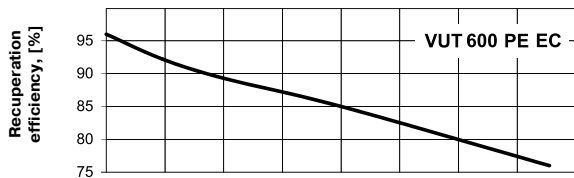
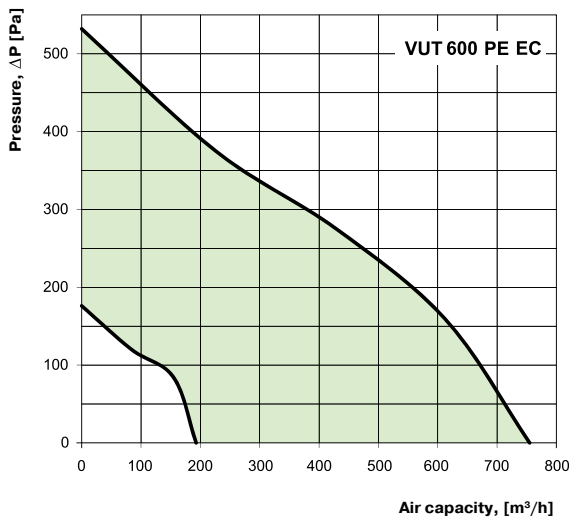

Sound power level	Hz	Octave frequency band [Hz]								
		Tot.	63	125	250	500	1000	2000	4000	8000
L_{WA} to inlet	dB(A)	55	35	56	53	43	47	45	37	28
L_{WA} to outlet	dB(A)	65	47	60	61	61	52	51	40	30
L_{WA} to environment	dB(A)	39	30	30	39	33	23	24	26	28

VENTS VUT PW EC

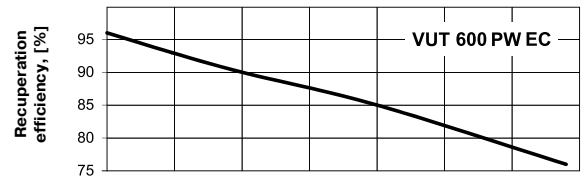
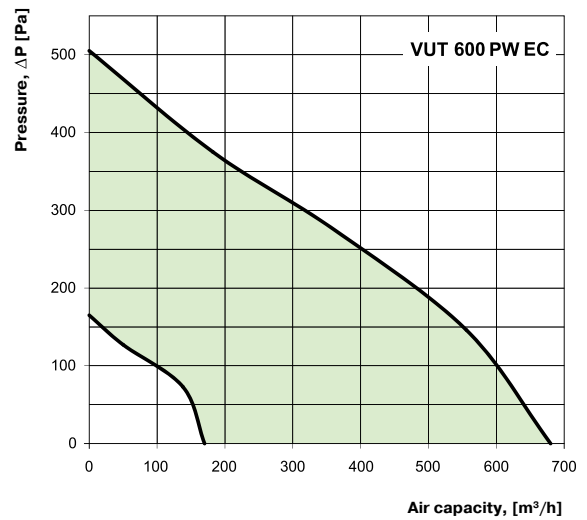

Sound power level	Hz	Octave frequency band [Hz]								
		Tot.	63	125	250	500	1000	2000	4000	8000
L_{WA} to inlet	dB(A)	59	34	56	54	43	46	44	36	24
L_{WA} to outlet	dB(A)	68	43	59	62	59	52	52	40	29
L_{WA} to environment	dB(A)	38	29	27	39	33	23	23	24	24

VENTS VUT PE EC

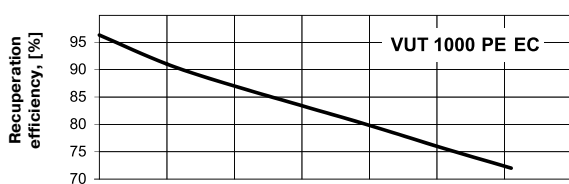
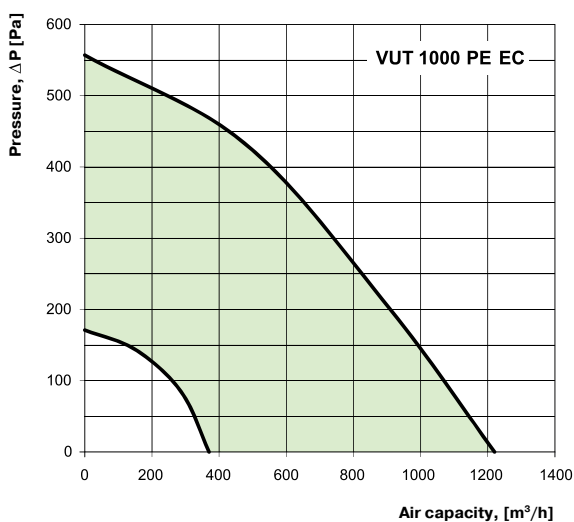

Sound power level	Hz	Octave frequency band [Hz]								
		Tot.	63	125	250	500	1000	2000	4000	8000
L_{WA} to inlet	dB(A)	68	67	68	70	68	60	60	61	55
L_{WA} to outlet	dB(A)	70	71	69	68	66	65	63	61	58
L_{WA} to environment	dB(A)	45	57	56	47	52	42	38	34	35

VENTS VUT PW EC

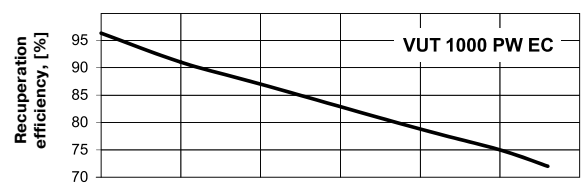
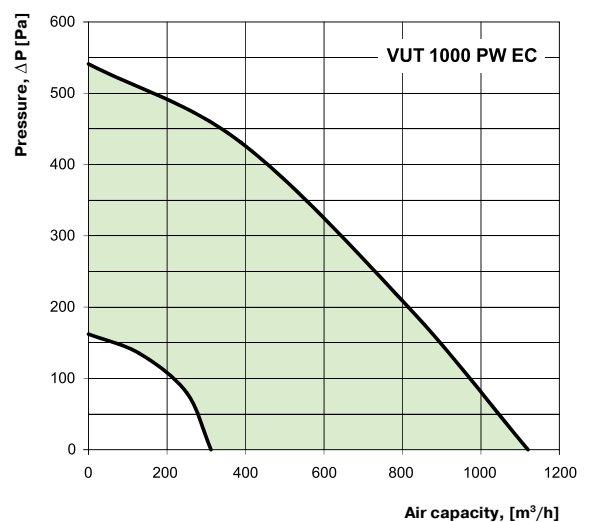

Sound power level	Hz	Octave frequency band [Hz]								
		Tot.	63	125	250	500	1000	2000	4000	8000
L_{WA} to inlet	dB(A)	67	68	67	67	66	59	61	61	56
L_{WA} to outlet	dB(A)	69	70	71	68	66	66	64	59	58
L_{WA} to environment	dB(A)	47	58	52	47	53	40	41	35	35

VENTS VUT PE EC

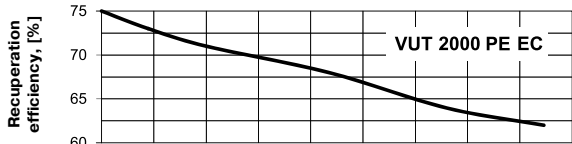
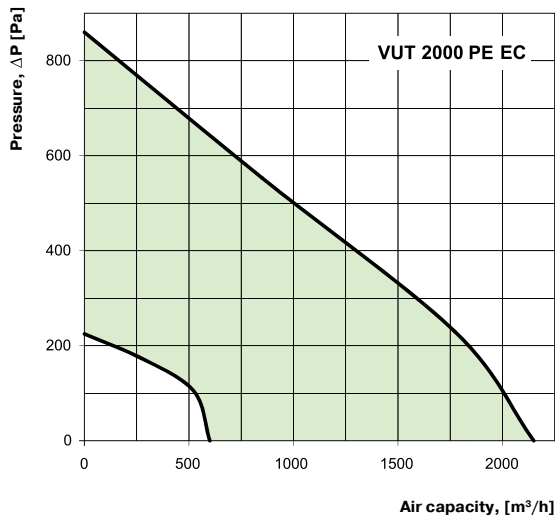

Sound power level	Hz	Octave frequency band [Hz]								
		Tot.	63	125	250	500	1000	2000	4000	8000
L_{WA} to inlet	dB(A)	77	83	83	78	72	73	66	67	58
L_{WA} to outlet	dB(A)	83	86	84	80	72	75	70	72	69
L_{WA} to environment	dB(A)	56	65	66	59	53	46	42	39	39

VENTS VUT PW EC

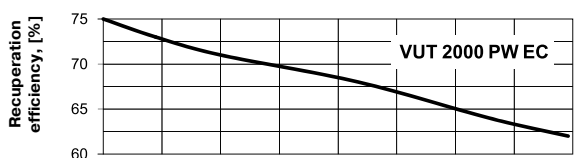
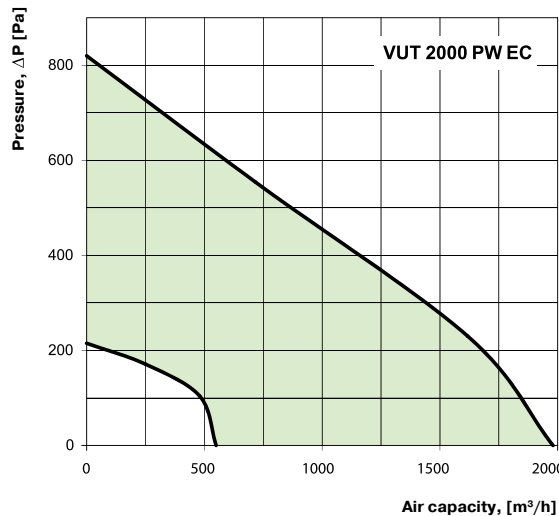

Sound power level	Hz	Octave frequency band [Hz]								
		Tot.	63	125	250	500	1000	2000	4000	8000
L_{WA} to inlet	dB(A)	79	80	80	79	71	72	69	64	58
L_{WA} to outlet	dB(A)	81	84	83	79	71	77	71	73	69
L_{WA} to environment	dB(A)	56	66	66	59	55	48	44	38	38

VENTS VUT PE EC

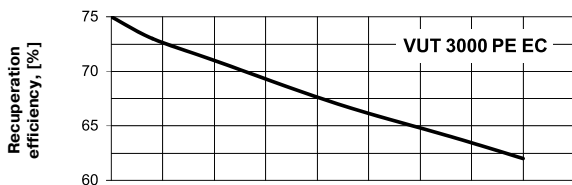
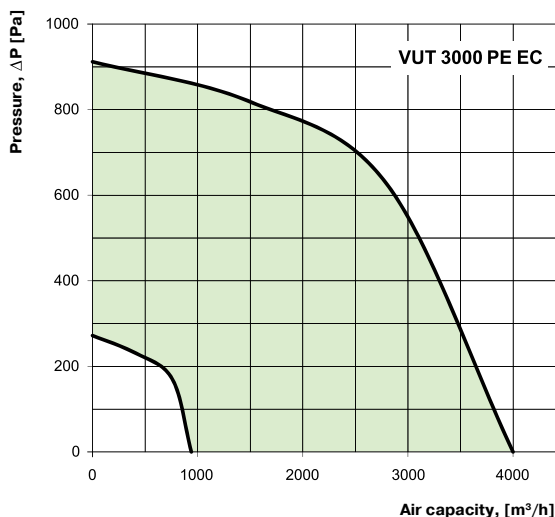

Sound power level	Hz	Octave frequency band [Hz]								
		Tot.	63	125	250	500	1000	2000	4000	8000
L_{WA} to inlet	dB(A)	80	85	83	82	75	75	72	70	64
L_{WA} to outlet	dB(A)	86	87	86	83	77	80	75	75	74
L_{WA} to environment	dB(A)	61	70	69	63	58	51	48	42	41

VENTS VUT PW EC

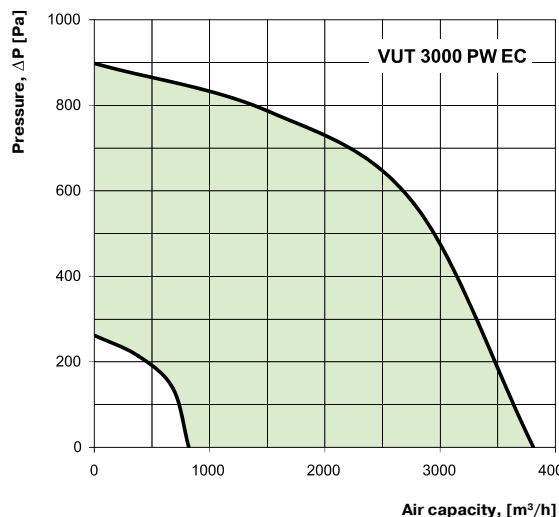

Sound power level	Hz	Octave frequency band [Hz]								
		Tot.	63	125	250	500	1000	2000	4000	8000
L_{WA} to inlet	dB(A)	82	87	83	84	75	72	72	69	63
L_{WA} to outlet	dB(A)	84	86	85	82	74	80	77	76	73
L_{WA} to environment	dB(A)	60	69	68	62	56	51	47	41	41

Hot water coil parameters:

VENTS VUT PW EC

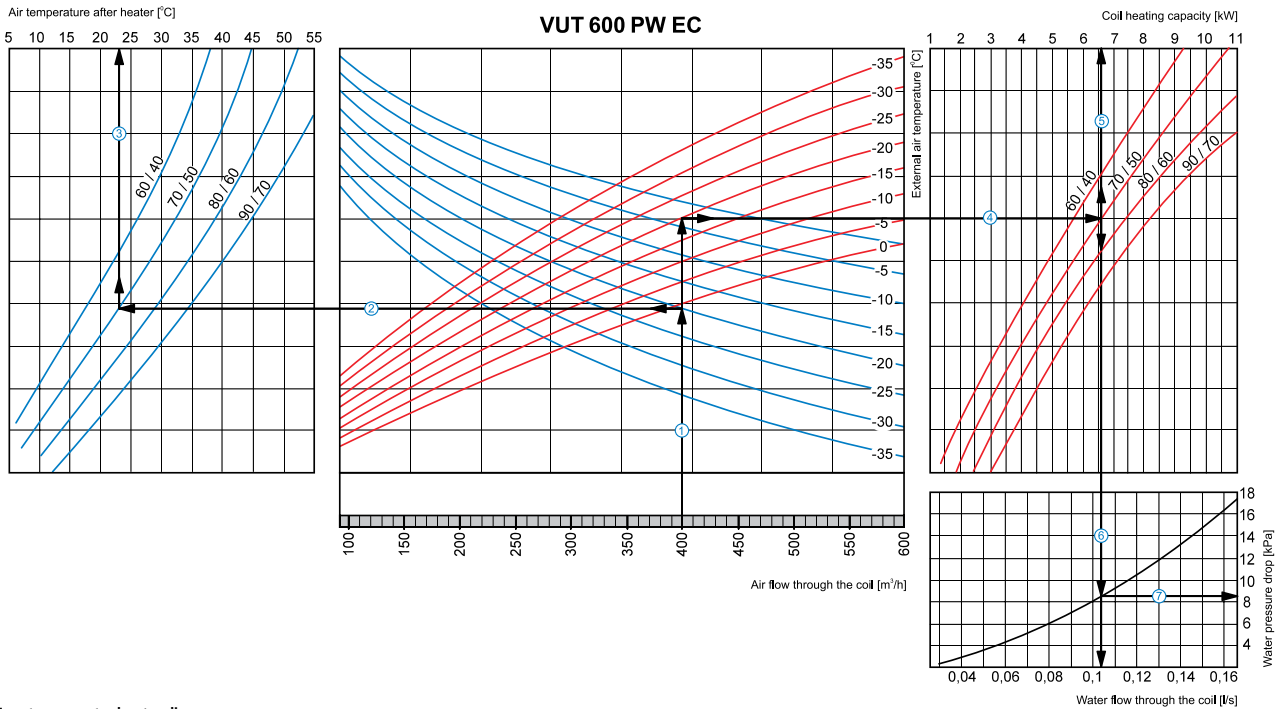

How to use water heater diagrams

System Parameters: Air flow = 400 m³/h. Outside air temperature = 20°C. Water temperature (in/out) = 70/50 °C.

- Supply air temperature. prolong the line of air flow (e.g., 400 m³/h) ① up to the point where it crosses the outside air temperature (blue curve, e.g. 20°C); then draw a horizontal line ② from this point to the left till crossing water in/out temperature curve (e.g. 70/50 °C). From this point draw a vertical line ③ to the supply air temperature axis on top of the graphic (+23°C).
- Heating coil capacity. Prolong the line ① up to the point where it crosses the outside air temperature (e.g. 20°C, red curve) and draw a horizontal line ④ from this point to the right until it crosses water in/out temperature curve (e.g., 70/50 °C), from here draw a vertical line ⑤ up to the scale representing the heating coil capacity (6.6 kW).
- Water discharge. Prolong the line ⑤ down to water discharge axis at the bottom of the graphic ⑥ (0.105 l/s).
- Water pressure drop. Draw the line ⑦ from the point where the line ⑥ crosses the black curve to the pressure drop axis. (8.5 kPa).

VENTS VUT PW EC

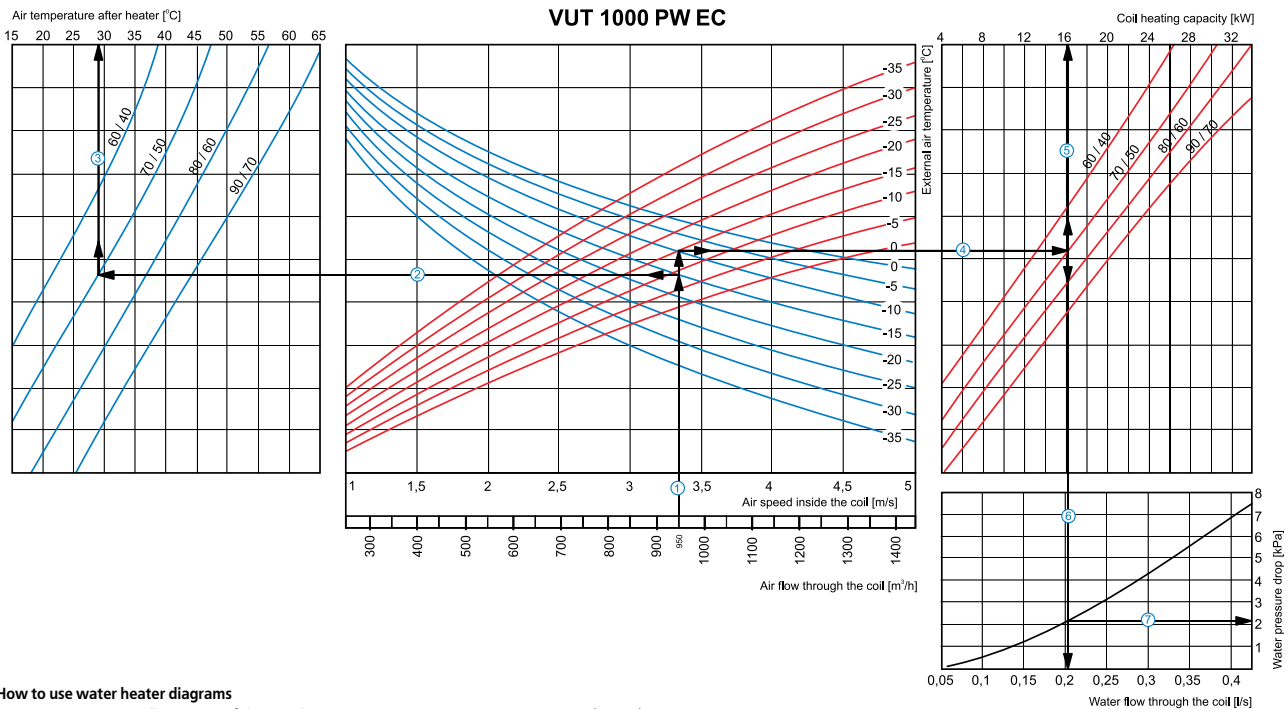

How to use water heater diagrams

System Parameters: Air flow = 950 m³/h. Outside air temperature = 15°C. Water temperature (in/out) = 70/50 °C.

- Air Speed. Starting from 950 m³/h on the air flow scale draw a vertical line ① till the air speed axis which makes about 3.35 m/s.
- Supply air temperature. prolong the line ① up to the point where it crosses the outside air temperature (blue curve, e.g. 15°C); then draw a horizontal line ② from this point to the left till crossing water in/out temperature curve (e.g. 70/50 °C). From this point draw a vertical line ③ to the supply air temperature axis on top of the graphic (+29°C).
- Heating coil capacity. Prolong the line ① up to the point where it crosses the outside air temperature (e.g. 15°C, red curve) and draw a horizontal line ④ from this point to the right until it crosses water in/out temperature curve (e.g., 70/50 °C), from here draw a vertical line ⑤ up to the scale representing the heating coil capacity (16.0 kW).
- Water discharge. Prolong the line ⑤ down to water discharge axis at the bottom of the graphic ⑥ (0.21 l/s).
- Water pressure drop. Draw the line ⑦ from the point where the line ⑥ crosses the black curve to the pressure drop axis. (2.1 kPa).

Hot water coil parameters:

VENTS VUT PW EC

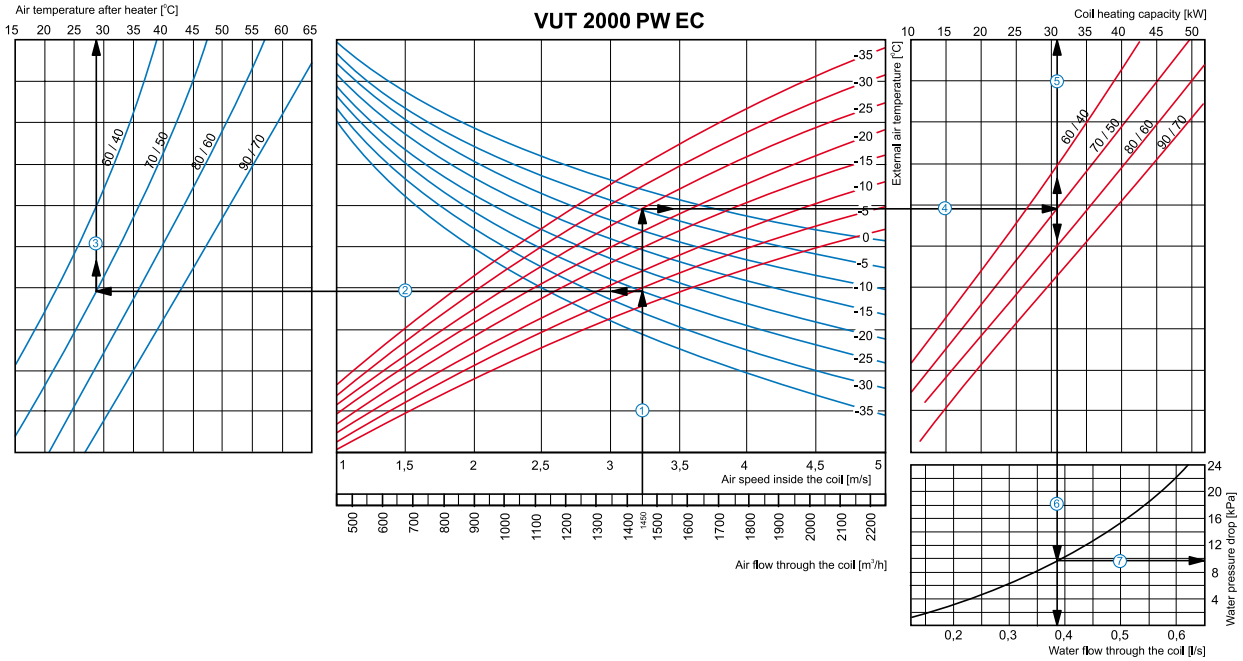

How to use water heater diagrams

System Parameters: Air flow = 1450 m³/h. Outside air temperature = -25°C. Water temperature (in/out) = 70/50 °C.

- Air Speed. Starting from 1450 m³/h on the air flow scale draw a vertical line ① till the air speed axis which makes about 3.2 m/s.
- Supply air temperature. prolong the line ① up to the point where it crosses the outside air temperature (blue curve, e.g. -25°C); then draw a horizontal line ② from this point to the left till crossing water in/out temperature curve (e.g. 70/50 °C). From this point draw a vertical line ③ to the supply air temperature axis on top of the graphic (+28°C).
- Heating coil capacity. Prolong the line ① up to the point where it crosses the outside air temperature (e.g. -25°C, red curve) and draw a horizontal line ④ from this point to the right until it crosses water in/out temperature curve (e.g., 70/50 °C), from here draw a vertical line ⑤ up to the scale representing the heating coil capacity (31.0 kW).
- Water discharge. Prolong the line ⑤ down to water flow axis at the bottom of the graphic ⑥ (0.38 l/s).
- Water pressure drop. Draw the line ⑦ from the point where the line ⑥ crosses the black curve to the pressure drop axis. (9.8 kPa).

VENTS VUT PW EC

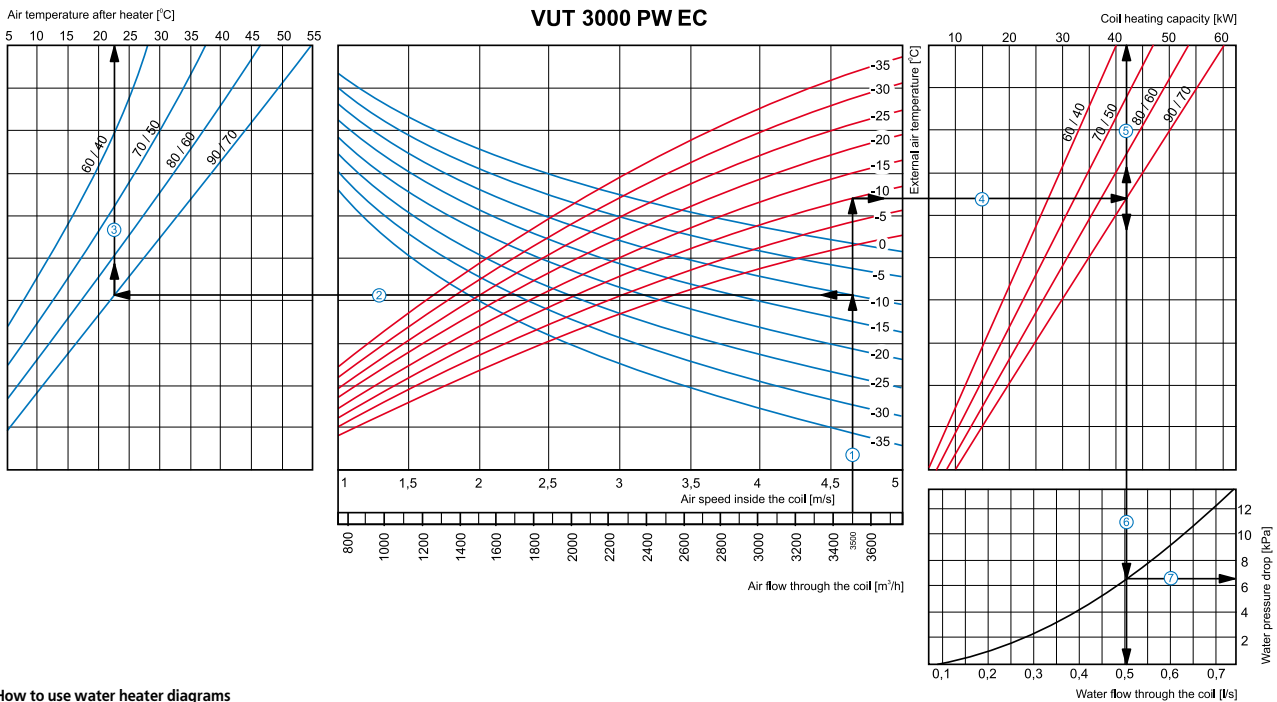

How to use water heater diagrams

System Parameters: Air flow = 3500 m³/h. Outside air temperature = -10°C. Water temperature (in/out) = 90/70 °C.

- Air Speed. Starting from 3500 m³/h on the air flow scale draw a vertical line ① till the air speed axis which makes about 4.65 m/s.
- Supply air temperature. prolong the line ① up to the point where it crosses the outside air temperature (blue curve, e.g. -10°C); then draw a horizontal line ② from this point to the left till crossing water in/out temperature curve (e.g. 90/70 °C). From this point draw a vertical line ③ to the supply air temperature axis on top of the graphic (+22,5°C).
- Heating coil capacity. Prolong the line ① up to the point where it crosses the outside air temperature (e.g. -10°C, red curve) and draw a horizontal line ④ from this point to the right until it crosses water in/out temperature curve (e.g., 90/70 °C), from here draw a vertical line ⑤ up to the scale representing the heating coil capacity (42.0 kW).
- Water discharge. Prolong the line ⑤ down to water flow axis at the bottom of the graphic ⑥ (0.5 l/s).
- Water pressure drop. Draw the line ⑦ from the point where the line ⑥ crosses the black curve to the pressure drop axis. (6.5 kPa).

VENTILATION SYSTEMS
www.ventilation-system.com

AIR HANDLING UNITS



VENTS reserves the rights to modify products for whatever constructive or commercial reason whenever necessary with no prior notice

10/2010